



Esco Multi-Zone ART Workstation & Airstream® for ART

Assisted Reproductive Technology (ART) Workstations



Experience Design Excellence.

The Esco Multi-Zone Workstation is packed with features that help ensure optimal results, especially for gamete and embryo manipulation during in vitro fertilization.

The Airstream® Laminar Flow comes in variants from 3 feet wide to 6 feet wide, with a side glass wall or a stainless steel wall. Choose the laminar flow bench model that fits your laboratory's requirements, not the other way around.



table of contents

Esco Multi-Zone ART Workstation

Parts and Features4

General Specifications13

Esco Multi-Zone ART Workstation with MIRI® Chambers

Parts and Features14

General Specifications19

Ordering Information21

Airstream® Horizontal and Vertical Laminar Flow

Parts and Features22

General Specifications28

Ordering Information33



Esco Multi-Zone ART Workstation



Esco Multi-Zone ART Workstation — for superior, gentle handling of your embryos

FEATURES:

Touchscreen Monitor

The touchscreen monitor is a fully functional Windows PC with exceptional features:

- Observe and record culture behavior in real-time via built-in microscope camera function.
- Provides real-time information of the zone performance and other work area parameters such as gas pressure and flow rate.

Multi-Zone Heating System with Four (4) Temperature Modes

There is one set point for 10 independent zones. Each zone has its own heating elements and sensors that allow for uniform heat distribution. The heating system will automatically prioritize power distribution to ensure effective temperature control with fast recovery.

- Temperature Accuracy: $\pm 0.2\text{ }^{\circ}\text{C}$
- Temperature Uniformity: $\pm 0.2\text{ }^{\circ}\text{C}$

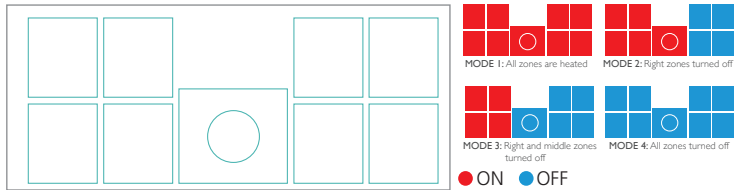

Humidification System

The humidification system allows for digital control of the premixed gas. This enables complete environmental control for the samples. The gas outlet port is located on the table surface. The plastic cover encloses the humidified gas which then creates a small incubator.

Heated Glass Stage

The heated glass stage has dedicated power supply to ensure temperature control and recovery in this zone.



SC-1 LED Light Source

Microscope Integration Provision

Having an integrated stereomicroscope in the work area makes it possible to handle embryos and gametes while keeping culture dishes at the right temperature. Fewer movements reduce the risk of accidents.



For Assisted Reproductive Technology (ART)

High-tech components and features are designed in Denmark and made in Esco's production facilities in Europe.

The workstation exemplifies Esco's world-class expertise and work quality in cleanroom technology.

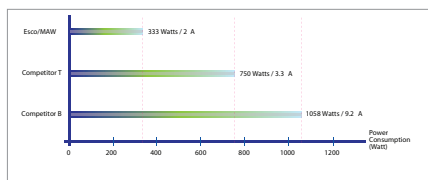

Energy Efficiency Chart

Esco ART Workstations utilize ECM blowers, allowing for low levels of cabinet power consumption without compromising cabinet performance.

It also has Standby mode that further reduces power consumption while the cabinet is not in use.

Air Cleanliness Standards (ISO 14644.1, Air Cleanliness Particle Limits) (No. of Particles / m ³)						
Particle Size (µm)	Cleanliness Class					
	Class 1	Class 2	Class 3	Class 4	Class 5	Class 6
0.1	10	100	1000	10000	100000	1000000
0.2	2	24	237	2370	23700	237000
0.3	1	10	102	1020	10200	102000
0.5	-	4	35	352	3520	35200
1.0	-	-	8	83	832	8320
5.0	-	-	-	3	29	293

Superior Air Cleanliness

Esco cabinets provide ISO Class 3 air cleanliness within the workzone as per ISO 14644.1, significantly cleaner than the conventional Class 4 classification offered by the competition.

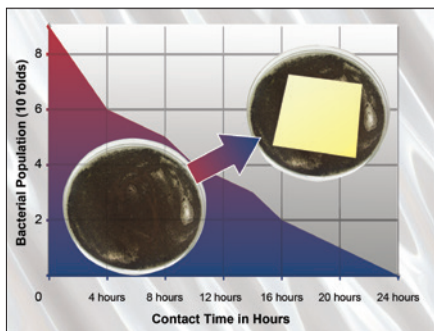

Isocide™ Powder Coat

Isocide™ is a silver-ion impregnated powder coat that inhibits microbial growth to improve safety.

Esco Multi-Zone ART Workstation

- Vertical laminar airflow providing sample protection
- Low-noise, energy-efficient ECM blowers
- Vibrations lessened by built-in dampers
- Has provisions for the integration of most microscopes
- Integrated heated glass stage
- Integrated SC-1 LED light source with dual-sided mirror and intensity control knob
- A selection of cabinet support stands
- Between 4ft. (single) and 6ft. (single, dual, multipurpose, or with MIRI® chambers) models



Less Noise, Less Vibrations

Esco Multi-Zone ART Workstation has a state-of-the-art design that allows for much lower noise and vibration levels, making the workstation suitable for sensitive microscopic work.

- 2x smaller high-efficiency ECM blower create lesser noise and vibrations than 1 big blower fan.
- Passive dampers, located along the connection of the tableplate to the cabinet frame, effectively diminish vibrations.

Cable Pass-Through Tunnels

The Esco Multi-Zone ART workstation has a convenient way for electrical cables of other equipment and/or accessories (i.e., a camera) to pass through its back wall. This provides a cleaner and more organized interior that should help improve your IVF workflow.

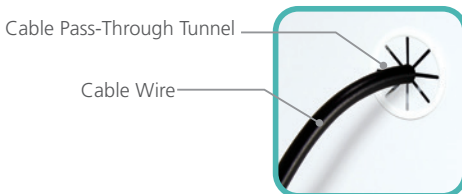

Esco Multi-Zone ART Workstation (MAW) Single Microscope

MAW-3D8

- Width: 3 Feet
- Microscope: Single
- Basic Configuration
- 1 user
- For small laboratories

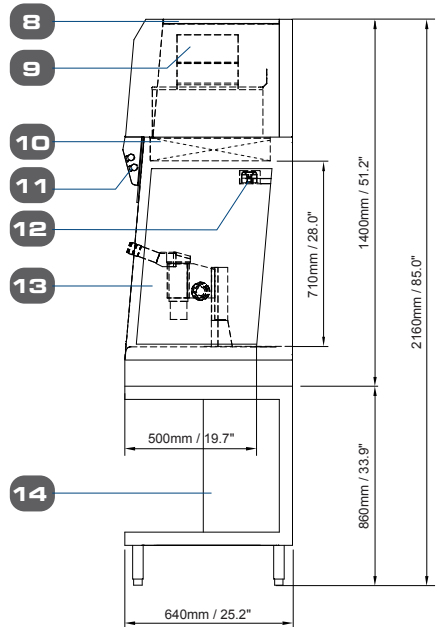
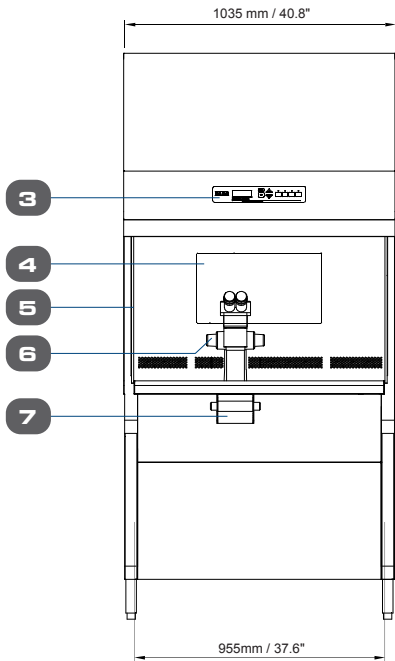
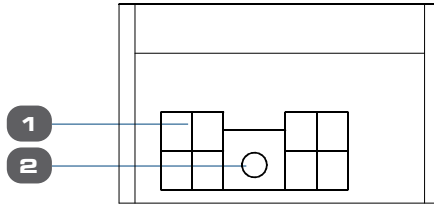

- | | | |
|--|---|------------------------------------|
| 1. Multi-Zone Heated Table Top (9+1 Zones) | 6. Provision for Microscope (Microscope not included) | 12. Airflow Sensor |
| 2. Integrated Heated Glass Stage | 7. Integrated LED Light Source, SC-1 | 13. Side Tempered Glass |
| 3. Esco Sentinel™ Gold Microprocessor Control System | 8. Pre-Filter | 14. Support Stand (Model: SML-4B0) |
| 4. Touchscreen Monitor (AIO PC) | 9. Blower | |
| 5. Side Tempered Glass | 10. ULPA Filter | |
| | 11. Fluorescent Light | |

Esco Multi-Zone ART Workstation [MAW] Single Microscope

Model: MAW-4D_

- Width: 4 Feet
- Microscope: Single
- Basic Configuration
- One User

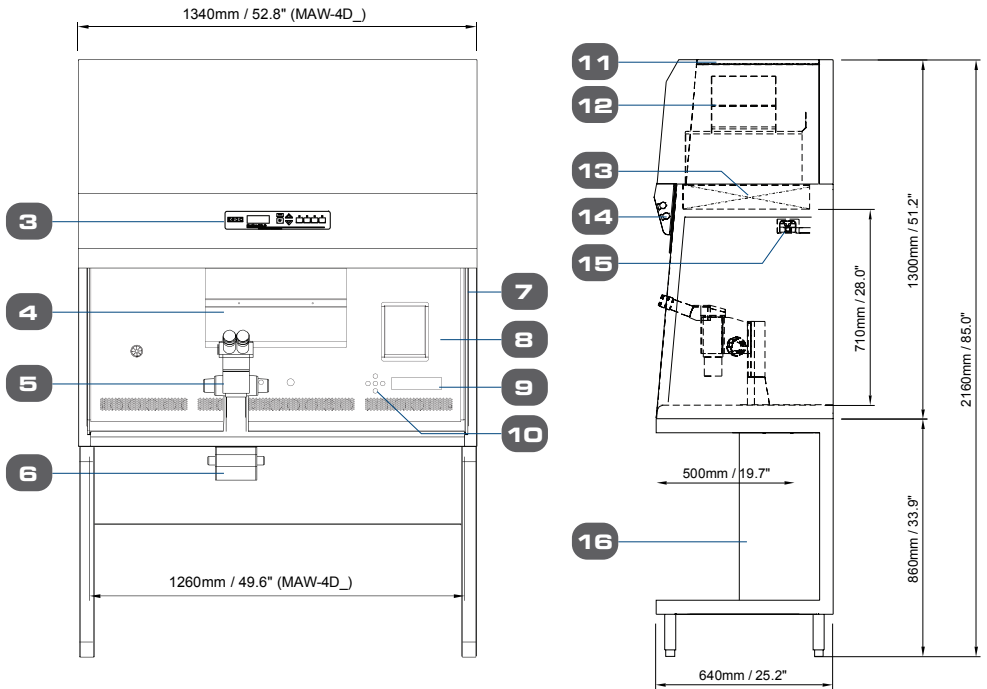
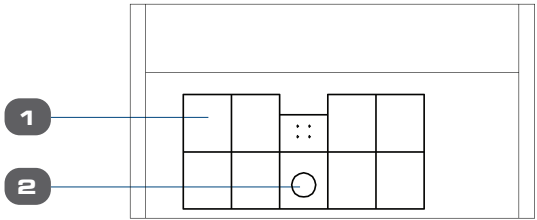

- | | | |
|---|---|------------------------------------|
| 1. Multi-Zone Heated Tabletop (9+1 Zones) | 6. Integrated LED Light Source, SC-1 | 11. Pre-Filter |
| 2. Integrated Heated Glass Stage | 7. Side Glass (Tempered) | 12. Blower |
| 3. Esco Sentinel™ Gold Microprocessor Control System | 8. Humidification System with Digital Flow Control of Pre-mixed Gas | 13. ULPA Filter |
| 4. Touchscreen Monitor (AIO PC) | 9. LED Display | 14. Fluorescent Light |
| 5. Provision for Microscope (Microscope not included) | 10. Control Panel for Heated Tabletop And Humidification System | 15. Airflow Sensor |
| | | 16. Support Stand (Model: SML-4B0) |

Esco Multi-Zone ART Workstation [MAW] Single Microscope

MAW-6D_MONO

- Width: 6 Feet
- Microscope: Single
- Basic Configuration
- One User
- More Space for Other Work

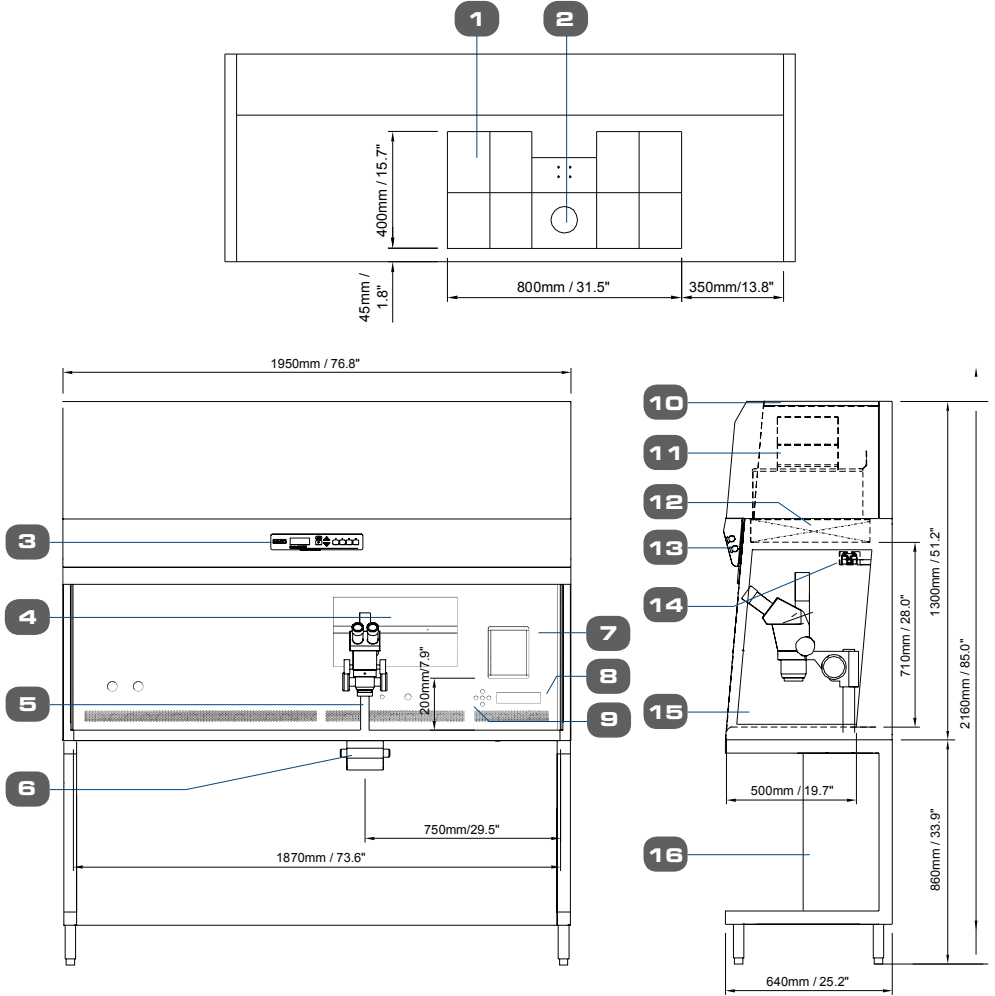

- | | | |
|---|---|------------------------------------|
| 1. Multi-Zone Heated Tabletop (9+1 Zones) | 6. Integrated LED Light Source, SC-1 | 12. ULPA Filter |
| 2. Integrated Heated Glass Stage | 7. Humidification System with Digital Flow Control of Pre-mixed Gas | 13. Fluorescent Light |
| 3. Esco Sentinel™ Gold Microprocessor Control System | 8. LED Display | 14. Airflow Sensor |
| 4. Touchscreen Monitor (AIO PC) | 9. Control Panel for Heated Tabletop And Humidification System | 15. Side Glass (Tempered) |
| 5. Provision for Microscope (Microscope is not included.) | 10. Pre-Filter | 16. Support Stand (Model: SML-6B0) |
| | 11. Blower | |

Esco Multi-Zone ART Workstation [MAW] Dual Microscope

Model: MAW-6D_DUAL

- Width: 6 Feet
- Microscope: Dual
- 2 users
- For Efficient Use of Space

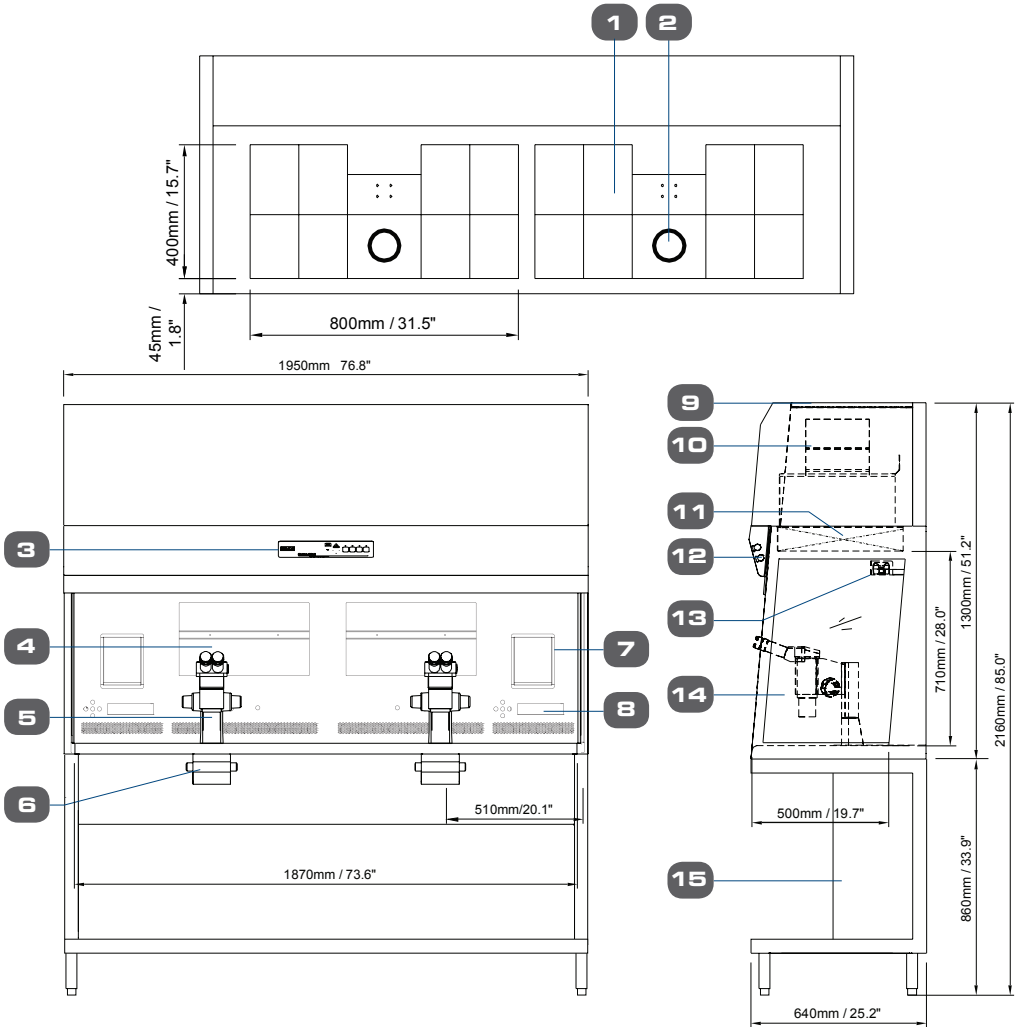

1. Multi-Zone Heated Tabletop (9+1 Zones)
2. Integrated Heated Glass Stage
3. Esco Sentinel™ Gold Microprocessor Control System
4. Touchscreen Monitor (AIO PC)
5. Provision for Microscope (Microscope is not included.)
6. Integrated LED Light Source, SC-1
7. Humidification System with Digital Flow Control of Pre-mixed Gas
8. Display Control Panel for Heated Tabletop and Humidification System
9. Pre-Filter
10. Blower
11. ULPA Filter
12. Fluorescent Light
13. Airflow Sensor
14. Side Glass (Tempered)
15. Support Stand (Model: SML-6B0)

Esco Multi-Zone ART Workstation [MAW] Multi-Purpose

Model: MAW-6D_MP

- Width: 6 Feet
- One Stereomicroscope
- One Inverted Microscope Set-Up
- Embryo Inspection and Micromanipulation

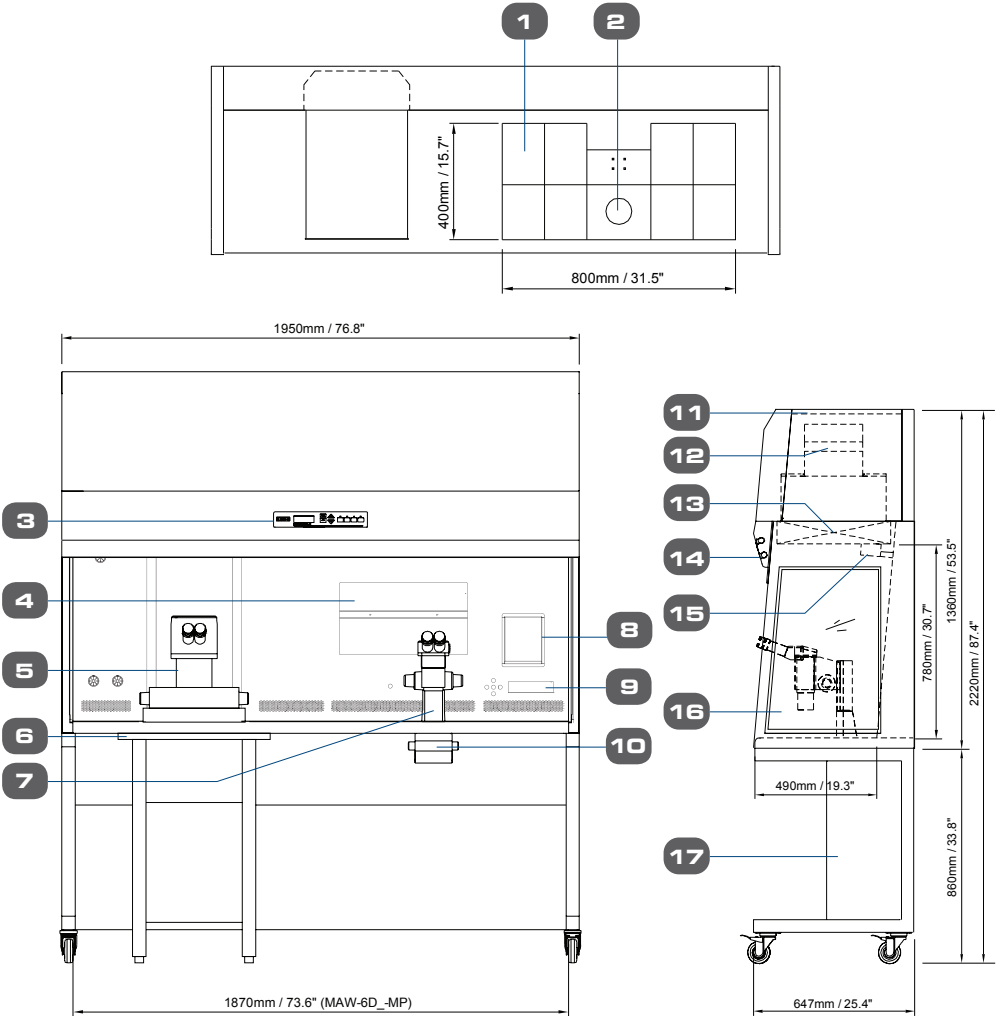

- | | | |
|--|--|------------------------------------|
| 1. Tabletop (9+1 Zones) | 7. Provision for Microscope (Microscope is not included.) | 11. Pre-Filter |
| 2. Integrated Heated Glass Stage | 8. Humidification System with Digital Flow Control of Pre-mixed Gas | 12. Blower |
| 3. Esco Sentinel™ Gold Microprocessor Control System | 9. Display Control Panel for Heated Tabletop and Humidification System | 13. ULPA Filter |
| 4. Touchscreen Monitor (AIO PC) | 10. Integrated LED Light Source, SC-1 | 14. Flourescent Light |
| 5. Inverted Microscope (Not Included) | | 15. Airflow Sensor |
| 6. Anti-Vibration Table (AVT) | | 16. Side Glass (Tempered) |
| | | 17. Support Stand (Model: SPC-6B0) |

General Specifications



Esco Multi-Zone ART Workstation (MAW)

Model	MAW-3D8	MAW-4D_	MAW-6D_-MONO	MAW-6D_-DUAL	MAW-6D_-MP
Nominal Size	0.9 meter (3')	1.2 meter (4')	1.8 meter (6')		
Internal Work area dimensions (width x depth x height)*	955 x 500 x 710 mm (37.6" x 19.7" x 28.0")	1260 x 500 x 710 mm (49.6" x 19.7" x 28.0")	1870 x 500 x 710 mm (73.6" x 19.7" x 28.0")		1870 x 490 x 780 mm (76.8" x 19.3" x 30.7")
External dimensions without support stand (width x depth x height)	1035 x 640 x 1400 mm (40.8" x 25.2" x 55")	1340 x 640 x 1300 mm (52.8" x 25.2" x 51.2")	1950 x 640 x 1300 mm (76.8" x 25.2" x 51.2")		1950 x 647 x 1360 mm (76.8" x 25.4" x 53.5")
External Dimensions with "B" type support stand (width x depth x height)	1035 x 640 x 2160 mm (40.8" x 25.2" x 85")	1340 x 640 x 2160 mm (52.8" x 25.2" x 85.0")	1950 x 640 x 2160 mm (76.8" x 25.2" x 85.0")		1950 x 647 x 2220 mm (76.8" x 25.4" x 87.4")
Cabinet Construction	Main Body	1.2 mm (0.05") 18 gauge electro-galvanized steel with white oven-baked epoxy-polyester powder coated finish			
	Work Zone	1.5 mm (0.6") gauge 16 stainless steel, grade 304	1.2 mm (0.05") 18 gauge stainless steel, grade 304		
	Side Walls	Tempered Glass (Optional: Polycarbonate sash for MAW with built-in UV light)			
	Sash				
Laminar air velocity	Average of 0.21m/s or 41 fpm (± 20%)				
Filter efficiency	>99.999% for particle size between 0.1 to 0.3 microns per IEST-RP-CC001.3 / H14 per EN 1822				
Pre-filter	Disposable and non-washable polyester fibers with 85% arrestance / EU3 rated				
Noise level (per NSF 49)**	<48 dBA	47 dBA	52 dBA		
Set of (9+1) heating zones	1 set	1 set	1 set	2 sets	1 set
Surveillance System with data logger	1 set	1 set	1 set	2 sets	1 set
Humidification System***	1 set	1 set	1 set	2 sets	1 set
PT 1000 ports	5 ports	5 ports	5 ports	10 ports	5 ports
Microscope	Required Not included (see microscope ordering information)				
	Position for 1 microscope			Position for 2 microscopes	Position for 1 microscope and 1 inverted microscope
Transmitted light source	1 set	1 set	1 set	2 sets	1 set
Support stand	Required, Not included (see support stand ordering information)				
Shipping dimensions (width x depth x height)	1120 X 820 X 1920 mm (44.1" x 32.3" x 75.6")	1450 x 850 x 1920 mm (57.1" x 33.5" x 75.6")	2050 x 850 x 1890 mm (80.8" x 33.5" x 74.4")		
Shipping weight	195 kg	280 kg	372 kg		

* The actual MAW-6D_-MP's work area dimension will be customized to fit the inverted microscope.

** Noise reading in open field condition / anechoic chamber. Noise reading in normal room varies by room size, layout, and background noise, but may reach roughly 3-4 dBA above these values.

***1 set of humidification system includes one (1) water bottle with tubing, one (1) sample carry tray and one (1) plastic cover.

Indication for Use Statement

The Esco Multi-Zone ART Workstation is a laminar flow workstation with controlled temperature and humidity working environment. The workstation is intended for working with gametes and / or embryos at / or near body temperature in a Multi-Zone heated set up during in vitro fertilization (IVF) / assisted reproductive technology (ART) treatments.



Caution

- Federal law restricts this device to sale by or on the order of a licensed healthcare practitioner.
- Only to be used by a trained and qualified professional. The device is sold under exemption specified in 21 CFR 801 Subpart D.

Esco Multi-Zone ART Workstation with MIRI® Chambers



The Esco is now even better with its integrated MIRI® chambers to further secure your embryos while inside the workstation. The MIRI® incubator is popular for its top-notch features such as stable culture environment and faster parameter recovery.



Multi-Zone Heating System

There is one set point for 8 (7+1) independent zones with their own heating elements and sensors.



MIRI® Chambers

Your specimens are more secure than ever with the integrated MIRI® chambers, known for their stable and precise temperature regulation.



UV Kit (Optional)*

It can hold a UV lamp for work zone decontamination. It also comes with polycarbonate front cover for UV shield and magnetic interlock for safety mechanism when the cover is removed.

Support Stand Options

The workstation offers more options to choose from to meet your requirements. Please see page 16.

Fit in the same MIRI® Inserts



Nunc™



Falcon®



Vitrolife



LifeGlobal®
GPS Dishes



Nipro™



SparMED Oosafe®

Accessories



Support Stand:

- With Leveling Feet
- With Caster Wheels
- Motorized Stand with Caster Wheels



UV Kit*

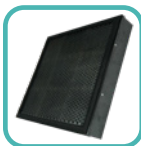

Carbon Filter



32 mm Microscope
pillar

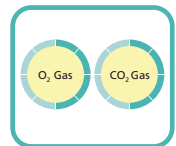

Tri-Gas Mixer for
MAW

*Esco reserves the right to make periodic minor design changes without obligation to notify any person or entity of such change.

Esco Multi-Zone ART Workstation [MAW] Single Microscope with MIRI® Chambers

Model: MAW-4D_MC

- Width: 4 Feet
- Microscope: Single
- Basic Configuration with 2 MIRI® Chambers
- One User
- For Small Laboratories

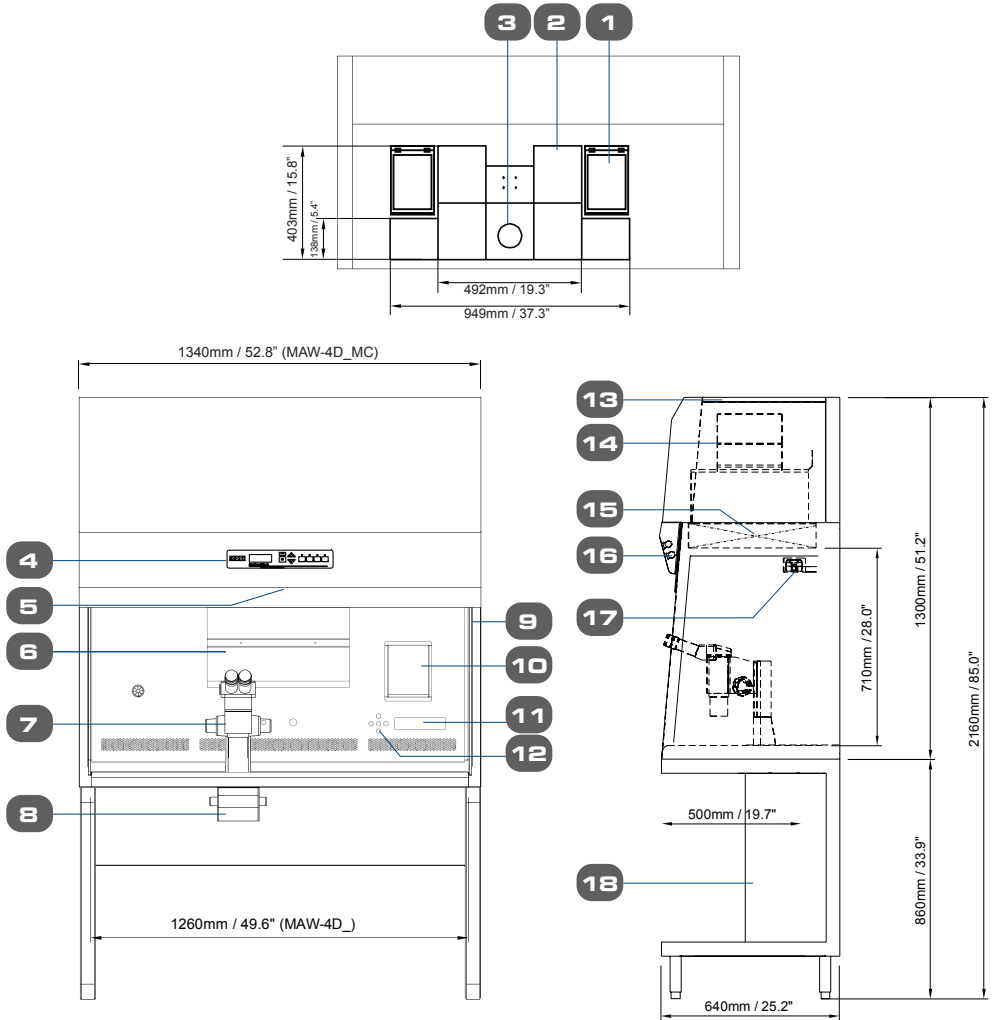

- MIRI® Chamber
- Multi-Zone Heated Tabletop
- Integrated Heated Glass Stage
- Esco Sentinel™ Gold Microprocessor Control System
- UV Light (optional accessory)
- Touchscreen Monitor (AIO PC)
- Provision for Microscope
- Integrated LED Light Source, SC-1
- Side Glass (Tempered)
- Humidification System with Digital Flow Control of Pre-mixed Gas
- LED Display
- Control Panel for Heated Tabletop And Humidification System
- Pre-filter
- Blower
- ULPA Filter
- Fluorescent Light
- Airflow Sensor
- Support Stand (Model: SML-4B0)

Esco Multi-Zone ART Workstation [MAW] Single Microscope with MIRI® Chambers

Model: MAW-6D_MONO-MC

- Width: 6Ft
- Microscope: Single
- Basic Configuration with 2 MIRI® Chambers
- One User
- More space for other work

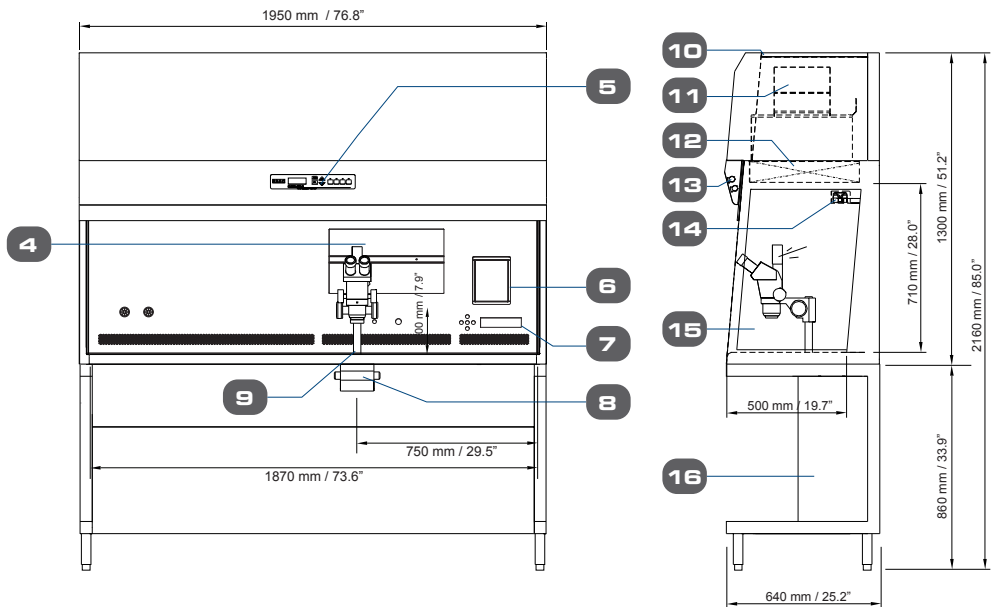
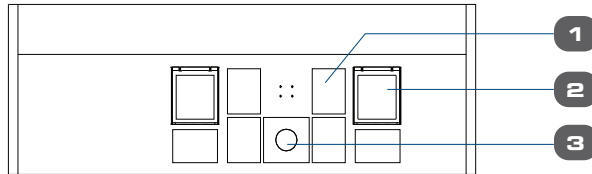

- | | | |
|---|--|------------------------------------|
| 1. Multi-Zone Heated Tabletop | 7. Display Control Panel for Heated Tabletop and Humidification System | 12. ULPA Filter |
| 2. MIRI® Chamber | 8. Integrated LED Light Source, SC-1 | 13. Fluorescent Light |
| 3. Integrated Heated Glass Stage | 9. Provision for Microscope (Microscope is not included.) | 14. Airflow Sensor |
| 4. Touchscreen Monitor (AIO PC) | | 15. Side Glass (Tempered) |
| 5. Esco Sentinel™ Gold Microprocessor Control System | | 16. Support Stand (Model: SML-6B0) |
| 6. Humidification System with Digital Flow Control of Pre-mixed Gas | 10. Pre-Filter | |
| | 11. Blower | |

Esco Multi-Zone ART Workstation [MAW] Dual Microscope with MIRI® Chambers

Model: MAW-6D_-DUAL-MC

- Width: 6Ft
- Microscope: Dual
- 2 Users
- For efficient use of space

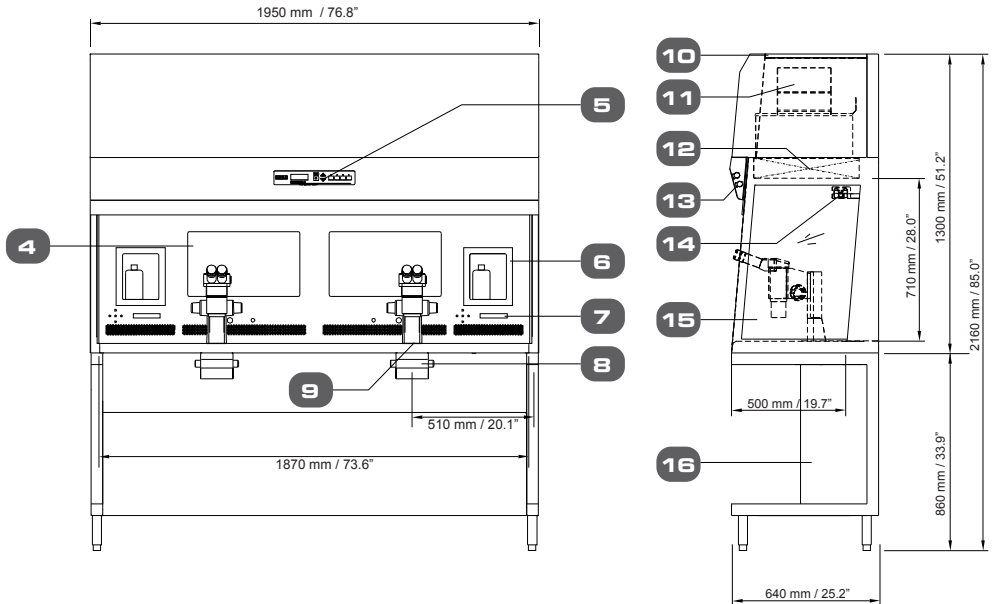
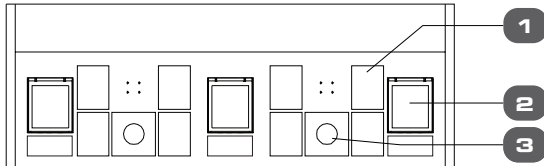

- | | | |
|---|--|------------------------------------|
| 1. Multi-Zone Heated Tabletop | 7. Display Control Panel for Heated Tabletop and Humidification System | 12. ULPA Filter |
| 2. MIRI® Chamber | 8. Integrated LED Light Source, SC-1 | 13. Fluorescent Light |
| 3. Integrated Heated Glass Stage | 9. Provision for Microscope (Microscope is not included.) | 14. Airflow Sensor |
| 4. Touchscreen Monitor (AIO PC) | 10. Pre-Filter | 15. Side Glass (Tempered) |
| 5. Esco Sentinel™ Gold Microprocessor Control System | 11. Blower | 16. Support Stand (Model: SML-6B0) |
| 6. Humidification System with Digital Flow Control of Pre-mixed Gas | | |

Esco Multi-Zone ART Workstation [MAW] MP with MIRI® Chambers

Model: MAW-6D_-MP-MC

- Width: 6 Feet
- Microscope: Single
- Multi-Purpose
- Embryo Inspection & Micromanipulation

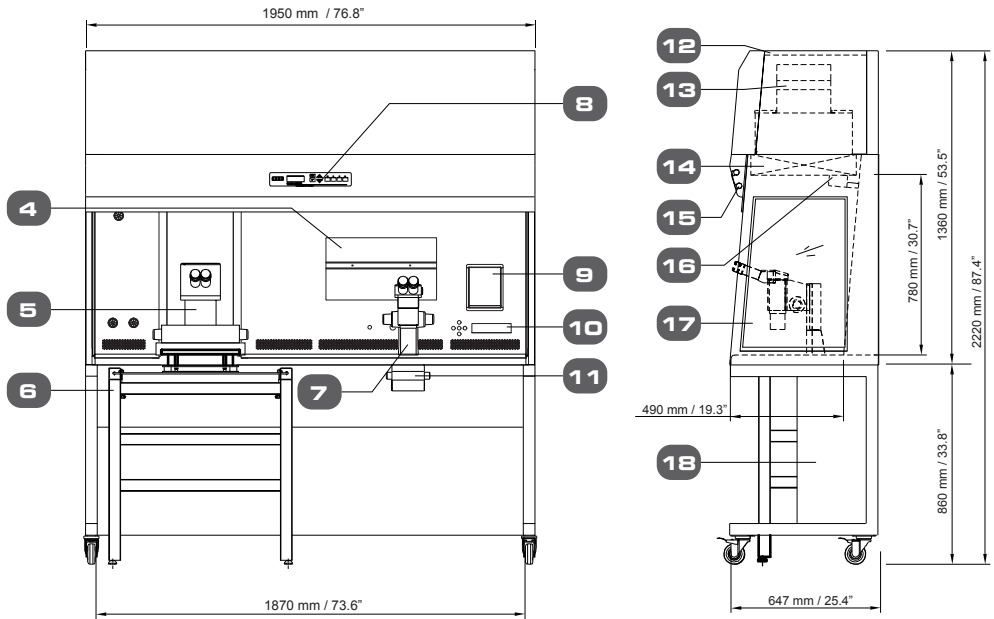
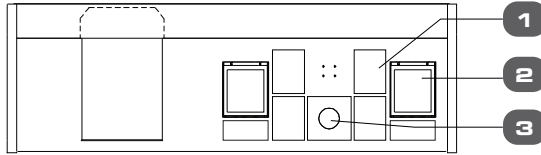

- | | | |
|---|---|-----------------------------|
| 1. Multi-Zone Heated Tabletop | 8. Esco Sentinel™ Gold Microprocessor Control System | 12. Pre-Filter |
| 2. MIRI® Chamber | 9. Humidification System with Digital Flow Control of Premixed Gas | 13. Blower |
| 3. Integrated Heated Glass Stage | 10. Display Control Panel for Heated Tabletop and Humidification System | 14. ULPA Filter |
| 4. Touchscreen Monitor (AIO PC) | 11. Integrated LED Light Source, SC-1 | 15. Fluorescent Light |
| 5. Inverted Microscope (Not Included) | | 16. Airflow Sensor |
| 6. Anti-Vibration Table (AVT) | | 17. Side Glass (Tempered) |
| 7. Provision for Microscope (Microscope is not included.) | | 18. Support Stand (SMC-6B0) |

General Specifications



Esco Multi-Zone ART Workstation (MAW) with MIRI® Chambers

Model	MAW-4D_-MC	MAW-6D_-MONO-MC	MAW6D_-DUAL-MC	MAW-6D_-MP-MC
Nominal Size	1.2 meter (4')	1.8 meter (6')	1.8 meter (6')	1.8 meter (6')
Internal Work Area, Dimensions (W x D x H)	1260 x 500 x 710 mm (49.6" x 19.7" x 28.0")	1870 x 500 x 710 mm (73.6" x 19.7" x 28.0")	1870 x 500 x 710 mm (83.6" x 19.7" x 28.0")	1870 x 490 x 780 mm (73.6" x 19.3" x 30.7")
External dimensions without support stand (W x D x H)	1340 x 640 x 1300 mm (52.8" x 25.2" x 51.2")	1950 x 640 x 1300 mm (76.8" x 25.2" x 51.2")	1950 x 640 x 1300 mm (76.8" x 25.2" x 51.2")	1950 x 647 x 1360 mm (76.8" x 25.4" x 53.5")
External Dimensions with "B" type support stand (W x D x H)	1340 x 640 x 2160 mm (52.8" x 25.2" x 85.0")	1340 x 640 x 2160 mm (52.8" x 25.2" x 85.0")	1950 x 640 x 2160 mm (76.8" x 25.2" x 85.0")	1950 x 647 x 2220 mm (76.8" x 25.4" x 87.4")
Cabinet Construction	Main Body	1.2 mm (0.05") 18 gauge electro-galvanized steel with white oven-baked epoxy-polyester powder-coated finish.		
	Work Zone	1.2 mm (0.05") 18 gauge stainless steel, grade 304		
	Side Walls	Tempered Glass (Optional: Polycarbonate sash for MAW with built-in UV light)		
	Sash			
Laminar air velocity	Average of 0.21m/s or 41 fpm (± 20%)			
Pre-Filter	Disposable, non-washable polyester fibre, 85% arrestance, EU3 rated			
ULPA Filter efficiency	>99.999% for particle size between 0.1 to 0.3 microns per IEST-RP-CC001.3 / H14 per EN 1822			
Set of (7+1) heating zones	1	1	2	1
Number of MIRI® Chambers	2	2	3	2
Included accessories	1 x water bottle for HS-1, including tubing 2 x sample carry tray	1 x water bottle for HS-1, including tubing 2 x sample carry tray	2 x water bottle for HS-1, including tubing 3 x sample carry tray	1 x water bottle for HS-1, including tubing 2 x sample carry tray
Microscope	Required, Not included (see microscope ordering information)			
	Position for 1 microscope	Position for 1 microscope	Position for 2 microscopes	Position for 1 microscope and 1 inverted microscope
Support stand	Required, Not included (see support stand ordering information)			

* 1 set of humidification system includes one (1) water bottle with tubing and one (1) sample carry tray.



Accessories

ITEM CODE	MODEL CODE	DESCRIPTION
5131413	SMC-3A0	Support Stand with Caster Wheels (Height 28") for 3ft Cabinets
5131414	SMC-3B0	Support Stand with Caster Wheels (Height 34") for 3ft Cabinets
5131415	SML-3A0	Support Stand with Leveling Feet (Height 28") for 3ft Cabinets
5131416	SML-3B0	Support Stand with Leveling Feet (Height 34") for 3ft Cabinets
5131417	SMTC-3A0	S/Stand Telescopic 3ft MAW, adjustable height
5171026	FC-MAW3-8	UV+Front Cover with magnetic interlock and bracket, MAW-3FT, 230V 50/60 Hz 5170799
5130179	SMC-4A0	Support Stand with Caster Wheels (Height 28") for 4ft Cabinets
5130180	SMC-6A0	Support Stand with Caster Wheels (Height 28") for 6ft Cabinets
5130181	SML-4A0	Support Stand with Leveling Feet (Height 28") for 4ft Cabinets
5130182	SML-6A0	Support Stand with Leveling Feet (Height 28") for 6ft Cabinets
5130183	SMC-4B0	Support Stand with Caster Wheels (Height 34") for 4ft Cabinets
5130184	SMC-6B0	Support Stand with Caster Wheels (Height 34") for 6ft Cabinets
5130185	SML-4B0	Support Stand with Leveling Feet (Height 34") for 4ft Cabinets
5130186	SML-6B0	Support Stand with Leveling Feet (Height 34") for 6ft Cabinets
5131255	SMC-4A8-M	Motorized Support Stand for 4ft Cabinet, Caster Wheels, Adjustable Height: 753mm to 1053mm, 230VAC 50/60Hz
5131266	SMC-4A9-M	Motorized Support Stand for 4ft Cabinet, Caster Wheels, Adjustable Height: 753mm to 1053mm, 115VAC 50/60Hz
5131264	SMC-6A8-M	Motorized Support Stand for 6ft Cabinet, Caster Wheels, Adjustable Height: 753mm to 1053mm, 230VAC 50/60Hz
5131267	SMC-6A9-M	Motorized Support Stand for 6ft Cabinet, Caster Wheels, Adjustable Height: 753mm to 1053mm, 115VAC 50/60Hz
1320075	MAW-WB1	Tube Warming Block
1320071	MAW-MS1	Stereomicroscope, Total magnification: 6.7X - 45X
5080185	MAW-CF	Carbon Filter (568 x 440 x 30 mm). Factory-Installed. Please order 2 units for 4 feet MAW and 3 units for 6 feet MAW
5090009	PF-MAW-2	Pre-Filter, 500 x 400 Polyester Media, PF-2
5090001	PF-MAW-12	Pre-Filter, 565 x 500, Polyester Media , PF-12
5170798	FC-MAW4-8	UV+Front Cover with magnetic interlock and bracket, MAW-4FT, 230V 50/60 Hz
5170799	FC-MAW6-8	UV+Front Cover with magnetic interlock and bracket, MAW-6FT, 230V 50/60 Hz
5170853	FC-MAW4-9	UV+Front Cover with magnetic interlock and bracket, MAW-4FT, 115V 50/60 Hz
5170854	FC-MAW6-9	UV+Front Cover with magnetic interlock and bracket, MAW-6FT, 115V 50/60 Hz
5170882	MAW-G	Gas Mixer for MAW (CO ₂ / O ₂ Gas mixing control in MAW). One (1) mixer needed for each MAW
5074858	MAW-PF	MAW-4/6 Pre-filter, 565 x 440, with plate for MAW-4/6 Standard

Ordering Information



ITEM CODE	MODEL CODE	DESCRIPTION
Esco Multi-Zone ART Workstation Basic Configuration and Multi-Purpose		
2070177	MAW-3D8	Esco Multi-Zone ART Workstation, 3ft 3ft (0.91m), 230V 50/60Hz
2070017	MAW-4D8	Esco Multi-Zone ART Workstation, 4ft (1.2m), 230V 50/60Hz
2070025	MAW-4D9	Esco Multi-Zone ART Workstation, 4ft (1.2m), 115V 50/60Hz
2070018	MAW-6D8-MONO	Esco Multi-Zone ART Workstation, 6ft (1.8m), 230V 50/60Hz
2070026	MAW-6D9-MONO	Esco Multi-Zone ART Workstation, 6ft (1.8m), 115V 50/60Hz
2070050	MAW-6D8-DUAL	Esco Multi-Zone ART Workstation, Double Heated Zone, 6ft (1.8m), 230V 50/60Hz
2070039	MAW-6D9-DUAL	Esco Multi-Zone ART Workstation, Double Heated Zone, 6ft (1.8m), 115V 50/60Hz
2070036	MAW-6D8-MP	Esco Multi-Zone ART Workstation, Multi-Purpose, 6ft (1.8m), 230V 50/60Hz
2070038	MAW-6D9-MP	Esco Multi-Zone ART Workstation, Multi-Purpose, 6ft (1.8m), 115V 50/60Hz
Esco ART Workstation with MIRI® Chambers		
2070068	MAW-4D8-MC	Esco Multi-Zone ART Workstation, MIRI® Chambers, 4ft (1.2m), 230V 50/60Hz
2070070	MAW-4D9-MC	Esco Multi-Zone ART Workstation, MIRI® Chambers, 4ft (1.2m), 115V 50/60Hz
2070069	MAW-6D8-MONO-MC	Esco Multi-Zone ART Workstation, MIRI® Chambers, 6ft (1.8m), 230V 50/60Hz
2070071	MAW-6D9-MONO-MC	Esco Multi-Zone ART Workstation, MIRI® Chambers, 6ft (1.8m), 115V 50/60Hz
2070075	MAW-6D8-DUAL-MC	Esco Multi-Zone ART Workstation, Double Heated Zone, MIRI® Chambers, 6ft (1.8m), 230V 50/60Hz
2070074	MAW-6D9-DUAL-MC	Esco Multi-Zone ART Workstation, Double Heated Zone, MIRI® Chambers, 6ft (1.8m), 115V 50/60Hz
2070072	MAW-6D8-MP-MC	Esco Multi-Zone ART Workstation, Multi-Purpose, MIRI® Chambers, 6ft (1.8m), 230V 50/60Hz
2070073	MAW-6D9-MP-MC	Esco Multi-Zone ART Workstation, Multi-Purpose, MIRI® Chambers, 6ft (1.8m), 115V 50/60Hz

Recommended List of Microscopes and the Base Stand Types

INVERTED MICROSCOPE FOR MP SERIES WORKSTATION ONLY
Olympus IX83P1ZF: One-Deck
Olympus IX73P1F: One-Deck (Customization on workstation needed)
Olympus IX73P2F: Two-Decks
Olympus IX53P1F: One-Deck (Customization on workstation needed)
Nikon Ti-U
Nikon Ti-S
Nikon Ti-E
Zeiss Axio Vert.A1
Zeiss Axio Vert.A1 FL
Zeiss Axio vert.A1 FL-LED

STEREOMICROSCOPE PROVISIONS	
MICROSCOPE TYPES	BASE STAND
Esco Stereomicroscope MS-1	Standard
Nikon SMZ series	C-PS / C-PS160 / C-DSS
Olympus SZX series	SZX-ST / SZX2-ST/SZ2-ST
Carl Zeiss	Stand N / V8 with T-pillar
Leica	S8AP0



Airstream®

Horizontal and Vertical Laminar Flow

Horizontal Laminar Flow

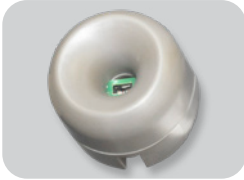

Airflow Sensor

- Monitors real-time airflow for safety
- Alerts the user if airflow is insufficient



Ergonomic Control Panel Location

- Centered and angled down for easy reach & viewing
- ADA-Compliant



Worktop

The spill-retaining worktop design with a recessed central area holds any accidental liquid spills.



Airstream® Horizontal Laminar Flow Clean Bench, Model LHG-4



Guide to Models

1st Placeholder Product Line	2nd Placeholder Flow	3rd Placeholder Side Wall	4th Placeholder Width	5th Placeholder Internal Height	6th Placeholder Control	7th Placeholder Window	8th Placeholder Electrical
Laminar Flow	L	Glass	3 feet	2 feet	Sentinel™ Gold	Fixed	230 VAC, 50 / 60 Hz
		Stainless Steel	4 feet	2.5 feet			115 VAC, 50 / 60 Hz
			5 feet	3 feet			
			6 feet				
			8 feet				

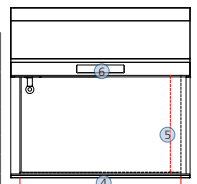

Example Code: LHG-4BG-F8

Specifications: Laminar flow cabinet, Horizontal Flow, Glass sided walls, 4 ft width, 2.5 ft internal height, Sentinel™ Gold microprocessor controller, Fixed window and 230 VAC, 50/60 Hz

FEATURES:

Energy-Efficient DC ECM Motor

- Powered by latest generation DC ECM motor that is more efficient than the legacy ECM and VFD motors
- 70% energy savings compared to an AC motor
- Stable airflow, despite building voltage fluctuations & filter loading
- Standby mode to further reduce power consumption (Standby mode provides ISO Class 5 workzone.)

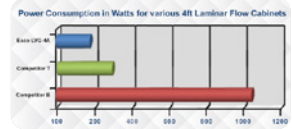
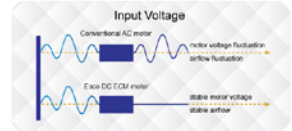

ULPA Filter

- The 10x filtration efficiency of HEPA filter creates ISO Class 3 work zone instead of industry-standard ISO Class 5.
- It deliver a 10x cleaner work zone than cabinets with HEPA filter.

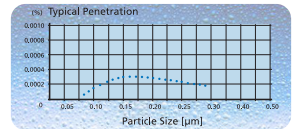

Sentinel™ Gold Microprocessor Controller

- Displays all safety information on one screen
- Standby mode switch to further save energy
- Programmable UV timer to extend UV lamp life



ISOCIDE™ Powder Coat

- Silver-ion impregnated powder coat
- Inhibits microbial growth to improve safety

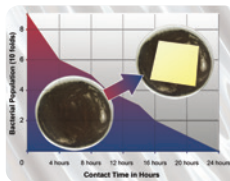

Quiet Operation

- World's leading low-noise laminar flow cabinet
- Comfortable noise level at 53 dBA *LVG-4A in an open field condition
- Reduces fatigue and improves work concentration

	Cabinet Performance	Air Quality	Filtration	Electrical Safety
Standards Compliance	IEST-RP-CC002.2, Worldwide	ISO 14644.1, Class 3, Worldwide AS 1386 Class 1.5, Australia JIS B9920, Class 3, Japan	EN-1822 (H14), Europe IEST-RP-CC001.3, Worldwide IEST-RP-CC007, Worldwide IEST-RP-CC034.1, Worldwide	IEC61010-1, Worldwide EN 61010-1, Europe UL61010-1, USA CAN/CSA-22.2, No.61010-1

Vertical Lamina Flow

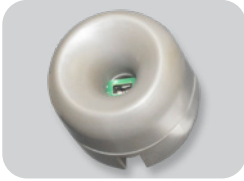

Airflow Sensor

- Monitors real-time airflow for safety
- Alerts the user if airflow is insufficient

Sash Window

- Polycarbonate Fixed Sash
- UV-Resistant Tempered Glass
- Manual Sliding Sash with Counter-Balance System (Only for LVG-XXX-SX)



Ergonomic Control Panel Location

- Centered and angled down for easy reach & viewing
- ADA-Compliant



Worktop

The spill-retaining worktop design with a recessed central area holds any accidental liquid spills.

Quiet Operation

- World's leading low-noise laminar flow cabinet
- Comfortable noise level at 53 dBA *LVG-4A in an open field condition
- Reduces fatigue and improves work concentration



Airstream® Vertical Laminar Flow Clean Bench, Model LVG-4AG-S8

FEATURES:

Energy-Efficient DC ECM Motor

- Powered by latest generation DC ECM motor that is more efficient than legacy ECM and VFD motors
- 70% energy savings compared to an AC motor
- Stable airflow, despite building voltage fluctuations & filter loading
- Standby mode to further reduce power consumption (Standby mode provide ISO Class 5 workzone.)

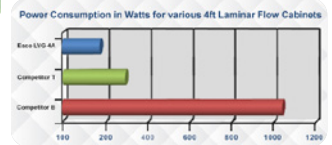
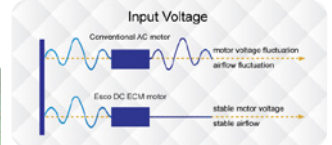

ULPA Filter

- The 10x filtration efficiency of HEPA filter creates ISO Class 3 work zone instead of industry-standard ISO Class 5.
- It deliver a 10x cleaner work zone than cabinets with HEPA filter.

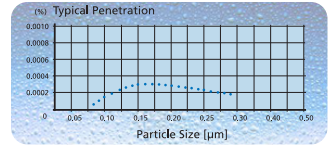

Sentinel™ Gold Microprocessor Controller

- Displays all safety information on one screen
- Standby mode switch to further save energy
- Programmable UV timer to extend UV lamp life



ISOCIDE™ Powder Coat

- Silver-ion impregnated powder coat
- Inhibits microbial growth to improve safety

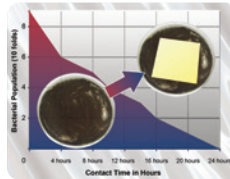

Guide to Models

1st Placeholder Product Line	2nd Placeholder Flow	3rd Placeholder Side Wall	4th Placeholder Width	5th Placeholder Internal Height	6th Placeholder Control	7th Placeholder Window	8th Placeholder Electrical								
Laminar Flow	L	Vertical	V	Glass	G	3 feet	3	2.25 feet	A	Sentinel™ Gold	G	Fixed	F	230 VAC, 50 / 60 Hz	8
		Stainless Steel	S	4 feet	4	3 feet	C			Rocker Switches		Sliding		115 VAC, 50 / 60 Hz	9
				5 feet	5										
				6 feet	6										
				8 feet	8										

Example Code: LVG-4AG-F8
 Specifications: Laminar Flow Cabinet, Vertical Flow, Glass sided walls, 4 ft width, 2.25 ft internal height, Sentinel™ Gold microprocessor controller, Fixed window, and 230 VAC, 50/60 Hz

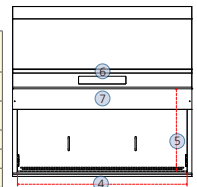

Vertical Laminar Flow

Cabinet Filtration System

- Room air is taken in from the top of the clean bench through a disposable pre-filter with 85% arrestance. This traps larger particles and increases the life of the main filter.
- Air is forced evenly across the ULPA/H14 filter. The result is a stream of clean laminar air within the workzone of the clean bench. This, in turn, dilutes and flushes all airborne contaminants from the interior.
- A nominal filter face velocity of 0.45 m/s or 90 fpm ensures that there is a sufficient number of air changes within the enclosed area of the clean bench to maintain cleanliness.
- The purified air travels across the working zone of the clean bench in a vertical, unidirectional stream and leaves the main work chamber across the entire open front of the clean bench and through Auto-Purge™ slots at the back wall of the work zone which are designed to eliminate air turbulence and the possibility of dead air corners in the work zone.

Airflow Diagram

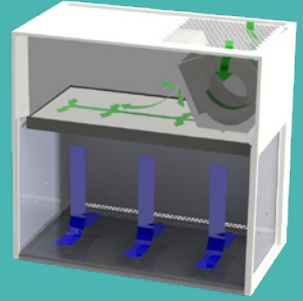

- ULPA-filtered air
- Room air / Inflow air

Engineering Drawing

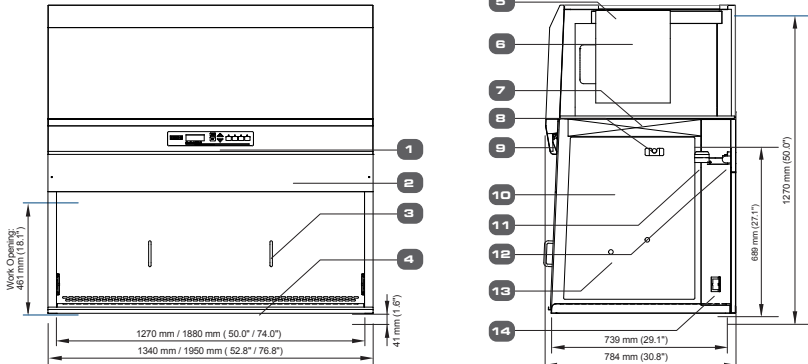

1. Esco Sentinel™ Gold Microprocessor Control System
2. Fixed Sash
3. Optional Front Cover
4. Stainless Steel Worktop
5. Pre-filter
6. DC ECM Blower (Self-compensating and lower noise)
7. ULPA filter
8. IV Bar Retrofit Kit Provision
9. Fluorescent Lamp
10. Tempered Glass Side Walls
11. Airflow Sensor
12. UV Lamp (Optional)
13. Service Fixture Retrofit Kit Provision (2 holes on each side)
14. Electrical Outlet Retrofit Kit provision (1 outlet on each side)

Esco Horizontal and Vertical Laminar Flow Clean Benches Front Cover

	3 feet	4 feet	5 feet	6 feet	8 feet
LHG / LHS	FC-LHG / LHS-3A 5170601	FC-LHG / LHS-4A 5170602	FC-LHG / LHS-5A 5170585	FC-LHG / LHS-6A 5170586	
	FC-LHG / LHS-3B 5170587	FC-LHG / LHS-4B 5170588	FC-LHG / LHS-5B 5170589	FC-LHG / LHS-6B 5170590	
	FC-LHG / LHS-3C 5170627	FC-LHG / LHS-4C 5170591		FC-LHG / LHS-6C 5170592	FC-LHG / LHS-8C 5170593
LVG / LVS	FC-LVG / LVS-3A 5170595	FC-LVG / LVS-4A 5170584	FC-LVG / LVS-5A 5170596	FC-LVG / LVS-6A 5170597	
		FC-LVG / LVS-4C 5170598	FC-LVG / LVS-5C 5170061	FC-LVG / LVS-6C 5170599	FC-LVG / LVS-8C 5170600

Horizontal Laminar Flow

Cabinet Filtration System

- Room air is taken in from the top of the clean bench through a disposable pre-filter with 85% arrestance. This traps larger particles and increases the life of the main filter.
- Air is forced evenly across the ULPA/H14 filter(s). The result is a stream of clean laminar air within the workzone of the clean bench. This, in turn, dilutes and flushes all airborne contaminants from the interior.
- A nominal filter face velocity of 0.45 m/s or 90 fpm ensures that there is a sufficient number of air changes within the enclosed area of the clean bench to maintain cleanliness.
- The purified air travels across the internal work zone of the clean bench in a horizontal, unidirectional stream and leaves the main work chamber across the entire open front of the clean bench.

Airflow Diagram

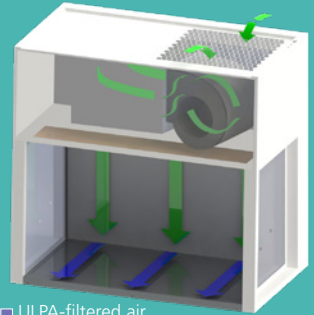

- ULPA-filtered air
- Room air / Inflow air

Engineering Drawing

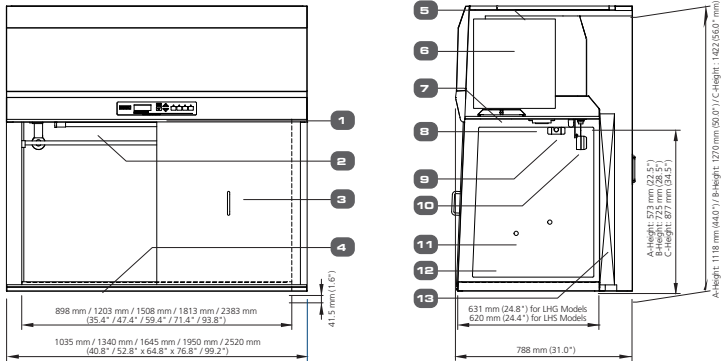

1. Esco Sentinel™ Gold Microprocessor Controller
2. UV Light Retrofit Kit Provision
3. (Optional) Front Cover
4. Spill-retaining Stainless Steel Work Top
5. Pre-filter

6. DC ECM Blower
7. Fluorescent Lamp
8. Electrical Outlet Provision (maximum of 2)
9. IV Bar Retrofit Kit Provision
10. Air Flow Sensor
11. Service Fixture Retrofit Kit

- Provision (2 on each side)
12. Tempered Glass Side Walls (for LHG Variant) Stainless Steel Side Walls (for LHS Variant)
 13. ULPA / H14 Filter

General Specifications



Airstream® Vertical Laminar Flow Clean Benches, A-Height (Interior Height: 2.25 ft / 0.7 m) with Sentinel™ Gold Microprocessor Control System

Stainless Steel Sides		LVS-3AG-F8 2120381	LVS-4AG-F8 2120382	LVS-5AG-F8 2120383	LVS-6AG-F8 2120384
			LVS-4AG-S8 2120759		LVS-6AG-S8 2120760
		LVS-3AG-F9 2120443	LVS-4AG-F9 2120445	LVS-5AG-F9 2120447	LVS-6AG-F9 2120449
			LVS-4AG-S9 2120762		LVS-6AG-S9 2120764
Glass Sides		LVG-3AG-F8 2120374	LVG-4AG-F8 2120369	LVG-5AG-F8 2120375	LVG-6AG-F8 2120407
			LVG-4AG-S8 2120701		LVG-6AG-S8 2120703
		LVG-3AG-F9 2120435	LVG-4AG-F9 2120437	LVG-5AG-F9 2120439	LVG-6AG-F9 2120441
		LVG-4AG-S9 2120761		LVG-6AG-S9 2120763	
Nominal Size		0.9 meter (3')	1.2 meter (4')	1.5 meter (5')	1.8 meter (6')
External Dimensions without Base Stand (W x D x H)	Fixed Sash Models	1035 x 784 x 1270 mm (40.8" x 30.8" x 50.0")	1340 x 784 x 1270 mm (52.8" x 30.8" x 50.0")	1645 x 784 x 1270 mm (64.8" x 30.8" x 50.0")	1950 x 784 x 1270 mm (76.8" x 30.8" x 50.0")
	Sliding Sash Models		1340 x 780 x 1270 mm (52.8" x 30.7" x 50.0")		1950 x 780 x 1270 mm (76.8" x 30.7" x 50.0")
Internal Work Area, Dimensions (W x D x H)	LVG Models (Fixed Sash)	965 x 739 x 689 mm (38.0" x 29.1" x 27.1")	1270 x 739 x 689 mm (50.0" x 29.1" x 27.1")	1575 x 739 x 689 mm (62.0" x 29.1" x 27.1")	1880 x 739 x 689 mm (74.0" x 29.1" x 27.1")
	LVG Models (Sliding Sash)		1270 x 695 x 689 mm (50.0" x 27" x 27.1")		1880 x 695 x 689 mm (74.0" x 27" x 27.1")
	LVS Models (Fixed Sash)	965 x 739 x 678 mm (38.0" x 29.1" x 26.7")	1270 x 739 x 678 mm (50.0" x 29.1" x 26.7")	1575 x 739 x 678 mm (62.0" x 29.1" x 26.7")	1880 x 739 x 678 mm (74.0" x 29.1" x 26.7")
	LVS Models (Sliding Sash)		1270 x 695 x 678 mm (50.0" x 27" x 26.7")		1880 x 695 x 678 mm (74.0" x 27" x 26.7")
Internal Work Area, Space		0.6 m ² (6.5 ft ²)	0.8 m ² (8.6 ft ²)	1.0 m ² (10.7 ft ²)	1.3 m ² (14.0 ft ²)
Average Airflow Velocity		0.45 m/s (90 fpm) at initial set point			
Air Volume		1117 m ³ /hr (657 cfm)	1471 m ³ /hr (866 cfm)	1824 m ³ /hr (1074 cfm)	2177 m ³ /hr (1281 cfm)
ULPA Filter Typical Efficiency		> 99.999% at particle size between 0.1 to 0.3µm			
Sound Emission per IEST-RP-CC002.2*		51.6 dBA	52.4 dBA	55.6 dBA	57.6 dBA
Fluorescent Lamp Intensity at Zero Ambient		980 Lux (94 foot candles)	904 Lux (84 foot candles)	894 Lux (83 foot candles)	1062 Lux (99 foot candles)
Cabinet Construction	Main Body	1.2 mm (0.05") 18-gauge electro-galvanized steel with white oven-baked epoxy-polyester powder-coated finish			
	Work Zone	1.2 mm (0.05") 18-gauge stainless steel, grade 304, with 4B finish			
	Side Walls	LVS Models: 1.2 mm (0.05") 18 gauge stainless steel, grade 304, with 4B finish			
		LVG Models: UV Resistant tempered glass, 5 mm (0.2"), colorless and transparent			
Sash Window	Fixed Sash: 5 mm (0.2") UV Resistant Polycarbonate Sash with 461 mm (18.1") opening				
	Manual Sliding Sash: 5 mm (0.2") UV Resistant Tempered Glass with counter-balance system and ergonomic handle				
Electrical Power Rating 8: 220-240 VAC, 50 / 60 Hz, 1 phase	Cabinet Full Load Amps (FLA)	7.3 A	7.5 A	7.8 A	8.5 A
	Optional Outlets (FLA)	5 A			
	Cabinet Nominal Power (W)	129	151	199	258
	Heat Rejected, BTU per Hour	440	515	679	880
Electrical Power Rating 9: 110-130 VAC, 50 / 60 Hz, 1 phase	Cabinet Full Load Amps (FLA)	12 A	12.5 A	13.3 A	13.5 A
	Optional Outlets (FLA)	5 A			
	Cabinet Nominal Power (W)	132	155	204	264
	Heat Rejected, BTU per Hour	450	529	696	908
Net Weight**		135 Kg (298 lbs)	158 Kg (348 lbs)	199 Kg (438 lbs)	208 Kg (459 lbs)
Shipping Weight**		167 Kg (368 lbs)	202 Kg (445 lbs)	256 Kg (564 lbs)	273 Kg (602 lbs)
Shipping Dimensions, Maximum (W x D x H)**		1120 x 900 x 1590 mm (44" x 35" x 62")	1400 x 900 x 1590 mm (55" x 35" x 62")	1720 x 900 x 1590 mm (68" x 35" x 62")	2200 x 900 x 1590 mm (87" x 35" x 62")
Shipping Volume, Maximum**		1.6 m ³ (56.6 ft ³)	2.0 m ³ (70.6 ft ³)	2.5 m ³ (88.2 ft ³)	3.3 m ³ (116.5 ft ³)

Specifications are subject to change without notice.

*Noise reading in open field condition / anechoic chamber. Noise reading in normal room varies by room size, layout, and background noise, but may reach roughly 3 dBA above these values.

**Cabinet only, excludes optional stand.

Airstream® Horizontal Laminar Flow Clean Benches, A-Height (Interior Height: 2 ft / 0.6 m)

Stainless Steel Sides		LHS-3AG-F8 2120377	LHS-4AG-F8 2120378	LHS-5AG-F8 2120379	LHS-6AG-F8 2120380
		LHS-3AG-F9 2120425	LHS-4AG-F9 2120427	LHS-5AG-F9 2120429	LHS-6AG-F9 2120431
Glass Sides		LHG-3AG-F8 2120387	LHG-4AG-F8 2120368	LHG-5AG-F8 2120372	LHG-6AG-F8 2120373
		LHG-3AG-F9 2120417	LHG-4AG-F9 2120419	LHG-5AG-F9 2120421	LHG-6AG-F9 2120423
Nominal Size		0.9 meter (3')	1.2 meter (4')	1.5 meter (5')	1.8 meter (6')
External Dimensions (W x D x H)	Without Base Stand	1035 x 795 x 1118 mm (40.8" x 31.3" x 44.0")	1340 x 795 x 1118 mm (52.8" x 31.3" x 44.0")	1645 x 795 x 1118 mm (64.8" x 31.3" x 44.0")	1955 x 795 x 1118 mm (76.8" x 31.3" x 44.0")
	Internal Work Area, Dimensions (W x D x H)	LHG Models	898 x 631 x 573 mm (35.4" x 24.8" x 22.5")	1203 x 631 x 573 mm (47.4" x 24.8" x 22.5")	1508 x 631 x 573 mm (59.4" x 24.8" x 22.5")
LHS Models		898 x 620 x 573 mm (35.4" x 24.4" x 22.5")	1203 x 620 x 573 mm (47.4" x 24.4" x 22.5")	1508 x 620 x 573 mm (59.4" x 24.4" x 22.5")	1813 x 620 x 573 mm (71.4" x 24.4" x 22.5")
Internal Work Area, Space		0.5 m ² (5.4 ft ²)	0.7 m ² (7.5 ft ²)	0.9 m ² (9.6 ft ²)	1.0 m ² (10.8 ft ²)
Average Airflow Velocity		0.45 m/s (90 fpm) at initial set point			
Air Volume		834 m ³ /hr (491 cfm)	1117 m ³ /hr (657 cfm)	1400 m ³ /hr (824 cfm)	1683 m ³ /hr (911 cfm)
ULPA Filter Typical Efficiency		> 99.999% at particle size between 0.1 to 0.3µm			
Sound Emission per IEST-RP-CC002.2*		53.2 dBA	55.8 dBA	58.4 dBA	60.0 dBA
Fluorescent Lamp Intensity at Zero Ambient		1045 Lux (97 foot candles)	1139 Lux (106 foot candles)	984 Lux (91 foot candles)	1221 Lux (113 foot candles)
Cabinet Construction	Main Body	1.2 mm (0.05") 18-gauge electro-galvanized steel with white oven-baked epoxy-polyester powder-coated finish			
	Work Zone	1.2 mm (0.05") 18-gauge stainless steel, grade 304, with 4B finish			
	Side Walls	LHS Models: 1.2 mm (0.05") 18 gauge stainless steel, grade 304, with 4B finish LHG Models: UV absorbing tempered glass, 5 mm (0.2"), colorless and transparent			
Electrical Power Rating 8: 220-240 VAC, 50 / 60 Hz, 1 phase	Cabinet Full Load Amps (FLA)	7 A	7.3 A	7.6 A	8 A
	Optional Outlets (FLA)	5 A			
	Cabinet Nominal Power (W)	140	171	211	249
	Heat Rejected, BTU per Hour	478	583	720	850
Electrical Power Rating 9: 110-130 VAC, 50 / 60 Hz, 1 phase	Cabinet Full Load Amps (FLA)	11.3 A	11.4 A	11.4 A	11.5 A
	Optional Outlets (FLA)	5 A			
	Cabinet Nominal Power (W)	144	175	216	255
	Heat Rejected, BTU per Hour	491	597	737	870
Net Weight**		100 Kg (220 lbs)	145 Kg (320 lbs)	167 Kg (368 lbs)	212 Kg (467 lbs)
Shipping Weight**		132 Kg (291 lbs)	200 Kg (440 lbs)	224 Kg (494 lbs)	277 Kg (611 lbs)
Shipping Dimensions, Maximum (W x D x H)**		1120 x 900 x 1590 mm (44" x 35" x 62")	1400 x 900 x 1590 mm (55" x 35" x 62")	1720 x 900 x 1590 mm (68" x 35" x 62")	2200 x 900 x 1590 mm (87" x 35" x 62")
Shipping Volume, Maximum**		1.6 m ³ (56.6 ft ³)	2.0 m ³ (70.6 ft ³)	2.5 m ³ (88.2 ft ³)	3.3 m ³ (116.5 ft ³)

Specifications are subject to change without notice.

*Noise reading in open field condition / anechoic chamber. Noise reading in normal room varies by room size, layout, and background noise, but may reach roughly 3 dBA above these values.

**Cabinet only, excludes optional stand.

Airstream® Horizontal Laminar Flow Clean Benches, B-Height (Interior Height: 2.5 ft / 0.8 m)

Stainless Steel Sides		LHS-3BG-F8 2120463	LHS-4BG-F8 2120465	LHS-5BG-F8 2120467	LHS-6BG-F8 2120469
		LHS-3BG-F9 2120503	LHS-4BG-F9 2120505	LHS-5BG-F9 2120507	LHS-6BG-F9 2120509
Glass Sides		LHG-3BG-F8 2120453	LHG-4BG-F8 2120455	LHG-5BG-F8 2120457	LHG-6BG-F8 2120459
		LHG-3BG-F9 2120493	LHG-4BG-F9 2120495	LHG-5BG-F9 2120497	LHG-6BG-F9 2120499
Nominal Size		0.9 meter (3')	1.2 meter (4')	1.5 meter (5')	1.8 meter (6')
External Dimensions (W x D x H)	Without Base Stand	1035 x 788 x 1270 mm (40.8" x 31.0" x 50.0")	1340 x 788 x 1270 mm (52.8" x 31.0" x 50.0")	1645 x 788 x 1270 mm (64.8" x 31.0" x 50.0")	1950 x 788 x 1270 mm (76.8" x 31.0" x 50.0")
	LHG Models	898 x 631 x 725 mm (35.4" x 24.8" x 28.5")	1203 x 631 x 725 mm (47.4" x 24.8" x 28.5")	1508 x 631 x 725 mm (59.4" x 24.8" x 28.5")	1813 x 631 x 725 mm (71.4" x 24.8" x 28.5")
Internal Work Area, Dimensions (W x D x H)	LHS Models	898 x 620 x 725 mm (35.4" x 24.4" x 28.5")	1203 x 620 x 725 mm (47.4" x 24.4" x 28.5")	1508 x 620 x 725 mm (59.4" x 24.4" x 28.5")	1813 x 620 x 725 mm (71.4" x 24.4" x 28.5")
	Internal Work Area, Space	0.5 m ² (5.4 ft ²)	0.7 m ² (7.5 ft ²)	0.9 m ² (9.6 ft ²)	1.0 m ² (10.8 ft ²)
Average Airflow Velocity		0.45 m/s (90 fpm) at initial set point			
Air Volume		1055 m ³ /hr (621 cfm)	1413 m ³ /hr (832 cfm)	1771 m ³ /hr (1042 cfm)	2129 m ³ /hr (1253 cfm)
ULPA Filter Typical Efficiency		> 99.999% at particle size between 0.1 to 0.3µm			
Sound Emission per IEST-RP-CC002.2*		52.8 dBA	55.4 dBA	58.0 dBA	59.6 dBA
Fluorescent Lamp Intensity at Zero Ambient		1279 Lux (119 foot candles)	1394 Lux (130 foot candles)	1204 Lux (112 foot candles)	1494 Lux (139 foot candles)
Cabinet Construction	Main Body	1.2 mm (0.05") 18-gauge electro-galvanized steel with white oven-baked epoxy-polyester powder-coated finish			
	Work Zone	1.2 mm (0.05") 18-gauge stainless steel, grade 304, with 4B finish			
	Side Walls	LHS Models: 1.2 mm (0.05") 18 gauge stainless steel, grade 304, with 4B finish LHG Models: UV absorbing tempered glass, 5 mm (0.2"), colorless and transparent			
Electrical Power Rating 8: 220-240 VAC, 50 / 60 Hz, 1 phase	Cabinet Full Load Amps (FLA)	7 A	7.3 A	7.6 A	8 A and 3 A (2 Power Inlet)
	Optional Outlets (FLA)	5 A			
	Cabinet Nominal Power (W)	160	207	255	302
	Heat Rejected, BTU per Hour	546	702	870	1030
Electrical Power Rating 9: 110-130 VAC, 50 / 60 Hz, 1 phase	Cabinet Full Load Amps (FLA)	11.3 A	11.4 A	11.4 A	11.5 A and 6.5 A (2 Power Inlet)
	Optional Outlets (FLA)	5 A			
	Cabinet Nominal Power (W)	163	211	260	308
	Heat Rejected, BTU per Hour	556	720	887	1051
Net Weight**		108 Kg (238 lbs)	156 Kg (344 lbs)	180 Kg (397 lbs)	228 Kg (503 lbs)
Shipping Weight**		140 Kg (308 lbs)	200 Kg (441 lbs)	237 Kg (522 lbs)	293 Kg (646 lbs)
Shipping Dimensions, Maximum (W x D x H)**		1120 x 900 x 1590 mm (44" x 35" x 62")	1400 x 900 x 1590 mm (55" x 35" x 62")	1720 x 900 x 1590 mm (68" x 35" x 62")	2200 x 900 x 1590 mm (87" x 35" x 62")
Shipping Volume, Maximum**		1.6 m ³ (56.6 ft ³)	2.0 m ³ (70.6 ft ³)	2.5 m ³ (88.2 ft ³)	3.3 m ³ (116.5 ft ³)

Specifications are subject to change without notice.

*Noise reading in open field condition / anechoic chamber. Noise reading in normal room varies by room size, layout, and background noise, but may reach roughly 3 dBA above these values.

**Cabinet only, excludes optional stand.

Airstream® Horizontal and Vertical Laminar Flow Clean Benches, C-Height (Interior Height: 3 ft / 0.9 m)

Model	Nominal Size	External Dimension (W x D x H)	Internal Dimension (W x D x H)	Sound Emission per IEST-RP-CC002.2*	Fluorescent Lamp Intensity at Zero Ambient	Cabinet Full Load Amps (FLA)	Cabinet Nominal Power (W)	Heat Rejected, BTU per Hour	Shipping Weight**	Shipping Dimensions, Maximum (W x D x H)**	Shipping Volume, Maximum**
VERTICAL LAMINAR FLOW (Power Rating 8: 220-240 VAC, 50 / 60 Hz, 1 phase)											
LVS-4CG-F8 2120565	4 ft (1.2 m)	1340 x 774 x 1645 mm (52.8" x 30.5" x 64.8")	1270 x 739 x 905 mm (50.0" x 29.1" x 35.6")	52.5 dBA	904 Lux (84 fc)	7.5 A	213	727	243 Kg (536 lbs)	1490 x 900 x 1750 mm (58.7" x 35.4" x 68.9")	2.3 m³ (81.2 ft³)
LVS-6CG-F8 2120569	6 ft (1.8 m)	1950 x 774 x 1645 mm (76.8" x 30.5" x 64.8")	1880 x 739 x 905 mm (74.0" x 29.1" x 35.6")	53.2 dBA	1062 Lux (99 fc)	8.5 A	392	1337	330 Kg (661 lbs)	2070 x 900 x 1750 mm (81.5" x 35.4" x 68.9")	3.3 m³ (116.5 ft³)
LVS-8CG-F8 2120686	8 ft (2.4 m)	2520 x 774 x 1645 mm (99.2" x 30.5" x 64.8")	2450 x 739 x 905 mm (96.5" x 29.1" x 35.6")	59.8 dBA	1100 Lux (102 fc)	8.5 A & 3.5 A	422	1446	455 Kg (1003 lbs)	2720 x 950 x 1750 mm (107" x 37.4" x 68.9")	4.5 m³ (158.9 ft³)
LVG-4CG-F8 2120555	4 ft (1.2 m)	1340 x 774 x 1645 mm (52.8" x 30.5" x 64.8")	1270 x 739 x 915 mm (50.0" x 29.1" x 36.0")	52.5 dBA	904 Lux (84 fc)	7.5 A	213	727	243 Kg (536 lbs)	1490 x 900 x 1750 mm (58.7" x 35.4" x 68.9")	2.3 m³ (81.2 ft³)
LVG-6CG-F8 2120559	6 ft (1.8 m)	1950 x 774 x 1645 mm (76.8" x 30.5" x 64.8")	1880 x 739 x 915 mm (74.0" x 29.1" x 36.0")	53.2 dBA	1062 Lux (99 fc)	8.5 A	392	1337	330 Kg (661 lbs)	2070 x 900 x 1750 mm (81.5" x 35.4" x 68.9")	3.3 m³ (116.5 ft³)
VERTICAL LAMINAR FLOW (Power Rating 9: 110-130 VAC, 50 / 60 Hz, 1 phase)											
LVS-4CG-F9 2120605	4 ft (1.2 m)	1340 x 774 x 1645 mm (52.8" x 30.5" x 64.8")	1270 x 739 x 905 mm (50.0" x 29.1" x 35.6")	52.5 dBA	904 Lux (84 fc)	11.5 A	217	741	243 Kg (536 lbs)	1490 x 900 x 1750 mm (58.7" x 35.4" x 68.9")	2.3 m³ (81.2 ft³)
LVS-6CG-F9 2120609	6 ft (1.8 m)	1950 x 774 x 1645 mm (76.8" x 30.5" x 64.8")	1880 x 739 x 905 mm (74.0" x 29.1" x 35.6")	53.2 dBA	1062 Lux (99 fc)	13.5 A	400	1365	330 Kg (661 lbs)	2070 x 900 x 1750 mm (81.5" x 35.4" x 68.9")	3.3 m³ (116.5 ft³)
LVS-8CG-F9 2120687	8 ft (2.4 m)	2520 x 774 x 1645 mm (99.2" x 30.5" x 64.8")	2450 x 739 x 905 mm (96.5" x 29.1" x 35.6")	59.8 dBA	1100 Lux (102 fc)	14 A & 8A	434	1481	455 Kg (1003 lbs)	2720 x 950 x 1750 mm (107" x 37.4" x 68.9")	4.5 m³ (158.9 ft³)
LVG-4CG-F9 2120595	4 ft (1.2 m)	1340 x 774 x 1645 mm (52.8" x 30.5" x 64.8")	1270 x 739 x 915 mm (50.0" x 29.1" x 36.0")	52.5 dBA	904 Lux (84 fc)	11.5 A	217	741	243 Kg (536 lbs)	1490 x 900 x 1750 mm (58.7" x 35.4" x 68.9")	2.3 m³ (81.2 ft³)
LVG-6CG-F9 2120599	6 ft (1.8 m)	1950 x 774 x 1645 mm (76.8" x 30.5" x 64.8")	1880 x 739 x 915 mm (74.0" x 29.1" x 36.0")	53.2 dBA	1062 Lux (99 fc)	13.5 A	400	1365	330 Kg (661 lbs)	2070 x 900 x 1750 mm (81.5" x 35.4" x 68.9")	3.3 m³ (116.5 ft³)
HORIZONTAL LAMINAR FLOW (Power Rating 8: 220-240 VAC, 50 / 60 Hz, 1 phase)											
LHS-4CG-F8 2120545	4 ft (1.2 m)	1340 x 782 x 1422 mm (52.8" x 30.8" x 56.0")	1203 x 620 x 877 mm (47.4" x 24.4" x 34.5")	56.4 dBA	934 Lux (87 fc)	7.3 A	246	840	222 Kg (489 lbs)	1400 x 900 x 1590 mm (55.1" x 35.4" x 62.5")	2.0 m³ (70.6 ft³)
LHS-6CG-F8 2120549	6 ft (1.8 m)	1950 x 782 x 1422 mm (76.8" x 30.8" x 56.0")	1813 x 620 x 877 mm (71.4" x 24.4" x 34.5")	59.4 dBA	1001 Lux (93 fc)	8 A & 3 A	359	1225	301 Kg (664 lbs)	2200 x 900 x 1590 mm (86.6" x 35.4" x 62.5")	3.3 m³ (116.5 ft³)
LHS-8CG-F8 2120704	8 ft (2.4 m)	2520 x 782 x 1422 mm (99.2" x 30.8" x 56.0")	2383 x 620 x 877 mm (93.8" x 24.4" x 34.5")	62.3 dBA	1136 Lux (106 fc)	8.3 A & 3.3 A	388	1324	397 Kg (875 lbs)	2720 x 950 x 1590 mm (107.0" x 37.4" x 62.5")	4.1 m³ (144.8 ft³)
LHG-3CG-F8 2120533	3 ft (0.9 m)	1035 x 782 x 1422 mm (40.8" x 30.8" x 56.0")	898 x 631 x 877 mm (35.4" x 24.8" x 34.5")	54.2 dBA	1195 Lux (111 fc)	7 A	190	648	147 Kg (324 lbs)	1120 x 900 x 1590 mm (44" x 35.4" x 62.5")	1.6 m³ (56.5 ft³)
LHG-4CG-F8 2120535	4 ft (1.2 m)	1340 x 782 x 1422 mm (52.8" x 30.8" x 56.0")	1203 x 631 x 877 mm (47.4" x 24.8" x 34.5")	56.4 dBA	934 Lux (87 fc)	7.3 A	246	840	222 Kg (489 lbs)	1400 x 900 x 1590 mm (55.1" x 35.4" x 62.5")	2.0 m³ (70.6 ft³)
LHG-6CG-F8 2120539	6 ft (1.8 m)	1950 x 782 x 1422 mm (76.8" x 30.8" x 56.0")	1813 x 631 x 877 mm (71.4" x 24.8" x 34.5")	59.4 dBA	1001 Lux (93 fc)	8 A & 3 A	359	1225	301 Kg (664 lbs)	2200 x 900 x 1590 mm (86.6" x 35.4" x 62.5")	3.3 m³ (116.5 ft³)
HORIZONTAL LAMINAR FLOW (Power Rating 9: 110-130 VAC, 50 / 60 Hz, 1 phase)											
LHS-4CG-F9 2120585	4 ft (1.2 m)	1340 x 782 x 1422 mm (52.8" x 30.8" x 56.0")	1203 x 620 x 877 mm (47.4" x 24.4" x 34.5")	56.4 dBA	934 Lux (87 fc)	11.4 A	250	853	222 Kg (489 lbs)	1400 x 900 x 1590 mm (55.1" x 35.4" x 62.5")	2.0 m³ (70.6 ft³)
LHS-6CG-F9 2120589	6 ft (1.8 m)	1950 x 782 x 1422 mm (76.8" x 30.8" x 56.0")	1813 x 620 x 877 mm (71.4" x 24.4" x 34.5")	59.4 dBA	1001 Lux (93 fc)	11.5 A & 6.5 A	365	1245	301 Kg (664 lbs)	2200 x 900 x 1590 mm (86.6" x 35.4" x 62.5")	3.3 m³ (116.5 ft³)
LHS-8CG-F9 2120719	8 ft (2.4 m)	2520 x 782 x 1422 mm (99.2" x 30.8" x 56.0")	2383 x 620 x 877 mm (93.8" x 24.4" x 34.5")	62.3 dBA	1136 Lux (106 fc)	12 A and 6 A	394	1344	397 Kg (875 lbs)	2720 x 950 x 1590 mm (107.0" x 37.4" x 62.5")	4.1 m³ (144.8 ft³)
LHG-3CG-F9 2120573	3 ft (0.9 m)	1035 x 782 x 1422 mm (40.8" x 30.8" x 56.0")	898 x 631 x 877 mm (35.4" x 24.8" x 34.5")	54.2 dBA	1195 Lux (111 fc)	11.3 A	193	659	147 Kg (324 lbs)	1120 x 900 x 1590 mm (44" x 35.4" x 62.5")	1.6 m³ (56.5 ft³)
LHG-4CG-F9 2120575	4 ft (1.2 m)	1340 x 782 x 1422 mm (52.8" x 30.8" x 56.0")	1203 x 631 x 877 mm (47.4" x 24.8" x 34.5")	56.4 dBA	934 Lux (87 fc)	11.4 A	250	853	222 Kg (489 lbs)	1400 x 900 x 1590 mm (55.1" x 35.4" x 62.5")	2.0 m³ (70.6 ft³)
LHG-6CG-F9 2120579	6 ft (1.8 m)	1950 x 782 x 1422 mm (76.8" x 30.8" x 56.0")	1813 x 631 x 877 mm (71.4" x 24.8" x 34.5")	59.4 dBA	1001 Lux (93 fc)	11.5 A & 6.5 A	365	1245	301 Kg (664 lbs)	2200 x 900 x 1590 mm (86.6" x 35.4" x 62.5")	3.3 m³ (116.5 ft³)
SPECIFICATIONS AVAILABLE FOR ALL MODELS AND SIZES											
Cabinet Construction	Main Body	1.2 mm (0.05") 18 gauge electro-galvanized steel with white oven-baked epoxy-polyester powder-coated finish									
	Work Zone	1.2 mm (0.05") 18-gauge stainless steel, grade 304, with 4B finish									
	Side Walls	LVG-LHG: UV absorbing tempered glass, 5 mm (0.2"), colorless and transparent LVS-LHS: 1.2 mm (0.05") 18 gauge stainless steel, grade 304, with 4B finish									
Average Airflow Velocity		0.45 m/s (90 fpm) at initial set point									
ULPA Filter Typical Efficiency		> 99.999% at particle size between 0.1 to 0.3 µm									
Electrical		Power Rating 8: 220-240 VAC, 50 / 60 Hz, 1 phase									
		Power Rating 9: 110-130 VAC, 50 / 60 Hz, 1 phase									

Specifications are subject to change without notice.

*Noise reading in open field condition / anechoic chamber. Noise reading in normal room varies by room size, layout, and background noise, but may reach roughly 3 dBA above these values.

**Cabinet only, excludes optional stand.

Accessories



Horizontal and Vertical Laminar Flow Clean Benches Accessories

MODEL		3 FEET WIDTH	4 FEET WIDTH	5 FEET WIDTH	6 FEET WIDTH	8 FEET WIDTH
UV Lamp		UV-15A-L 5170251		UV-30A-L 5170255		UV-30A-L *2
Electrical Outlet		EO-				
IV Bar Horizontal Flow		IV-890 5170608	IV-1195 5170609	IV-1500 5170610	IV-1805 5170611	IV-2375 5170662
IV Bar Vertical Flow		IV-960 5170603	IV-1265 5170604	IV-1570 5170605	IV-1875 5170606	IV-2445 5170607
PVC Arm Rest		ME-W-REST 5170127				
Height-adjustable Lab Chair (Blue)		ME-LD-AR360 1150006				
Ergonomic Foot Rest		FT-REST 5170073				
Support Stand Telescoping with Castors (28" to 34")		STC-3A0 5130055	STC-4A0 5130056	STC-5A0 5130057	STC-6A0 5130058	STC-8A0 Gen2 5131146
Support Stand Telescoping with Leveling Feet (28" to 34")		STL-3A0 5130050	STL-4A0 5130051	STL-5A0 5130052	STL-6A0 5130053	STL-8A0 Gen2 5131150
Support Stand with Leveling Feet (28")		SAL-3A0 Gen2 5130170	SAL-4A0 Gen2 5130134	SAL-5A0 Gen2 5130171	SAL-6A0 Gen2 5130172	SAL-8A0 Gen2 5131124
Support Stand with Leveling Feet (34")		SAL-3B0 Gen2 5130174	SAL-4B0 Gen2 5130175	SAL-5B0 Gen2 5130176	SAL-6B0 Gen2 5130177	SAL-8B0 Gen2 5131125
Pre-filter	Horizontal	PF-4 5090003	PF-2 (2 pcs) 5090001	PF-3 and PF-4 5090002 and 5090003	PF-2 (3 pcs) 5090001	PF-2 and PF-4 (2 pcs) 5090001 and 5090003
	Vertical				PF-4 (2 pcs) 5090003	

Recommendations on Selecting the Most Suitable Laminar Flow Equipment

- Determine your application needs:
 - Sensitive samples - use the Horizontal Type (nearer to filter for better product protection)
 - Large samples - use the Vertical Type
- Determine your work area needs (2 ft to 3 ft work zone height)
- Determine your laboratory space (3 ft to 8 ft external width)
- Determine your convenience (glass sidewall or stainless steel sidewall)



Ordering Information



Laminar Flow Clean Benches

PRODUCT MATRIX			220-240 VAC, 50/60 HZ		110-130 VAC, 50/60 HZ	
Vertical	Stainless Steel Sides	2.25 ft Internal Height	2120381	LVS-3AG-F8	2120443	LVS-3AG-F9
			2120382	LVS-4AG-F8	2120445	LVS-4AG-F9
			2120759	LVS-4AG-S8	2120762	LVS-4AG-S9
			2120383	LVS-5AG-F8	2120447	LVS-5AG-F9
			2120384	LVS-6AG-F8	2120449	LVS-6AG-F9
			2120760	LVS-6AG-S8	2120764	LVS-6AG-S9
		3 ft Internal Height	2120565	LVS-4CG-F8	2120605	LVS-4CG-F9
			2120569	LVS-6CG-F8	2120609	LVS-6CG-F9
			2120686	LVS-8CG-F8	2120687	LVS-8CG-F9
	Glass Sides	2.25 ft Internal Height	2120374	LVG-3AG-F8	2120435	LVG-3AG-F9
			2120369	LVG-4AG-F8	2120437	LVG-4AG-F9
			2120701	LVG-4AG-S8	2120761	LVG-4AG-S9
			2120375	LVG-5AG-F8	2120439	LVG-5AG-F9
			2120380	LVG-6AG-F8	2120441	LVG-6AG-F9
			2120703	LVG-6AG-S8	2120763	LVG-6AG-S9
		3 ft Internal Height	2120555	LVG-4CG-F8	2120595	LVG-4CG-F9
			2120559	LVG-6CG-F8	2120599	LVG-6CG-F9
Horizontal	Stainless Steel Sides	2 ft Internal Height	2120377	LHS-3AG-F8	2120425	LHS-3AG-F9
			2120378	LHS-4AG-F8	2120427	LHS-4AG-F9
			2120379	LHS-5AG-F8	2120429	LHS-5AG-F9
			2120380	LHS-6AG-F8	2120431	LHS-6AG-F9
		2.5 ft Internal Height	2120463	LHS-3BG-F8	2120503	LHS-3BG-F9
			2120465	LHS-4BG-F8	2120505	LHS-4BG-F9
			2120467	LHS-5BG-F8	2120507	LHS-5BG-F9
			2120469	LHS-6BG-F8	2120509	LHS-6BG-F9
		3 ft Internal Height	2120545	LHS-4CG-F8	2120585	LHS-4CG-F9
			2120549	LHS-6CG-F8	2120589	LHS-6CG-F9
			2120704	LHS-8CG-F8	2120719	LHS-8CG-F9
	Glass Sides	2 ft Internal Height	2120387	LHG-3AG-F8	2120417	LHG-3AG-F9
			2120368	LHG-4AG-F8	2120419	LHG-4AG-F9
			2120372	LHG-5AG-F8	2120421	LHG-5AG-F9
			2120373	LHG-6AG-F8	2120423	LHG-6AG-F9
			2120453	LHG-3BG-F8	2120493	LHG-3BG-F9
			2120455	LHG-4BG-F8	2120495	LHG-4BG-F9
		2.5 ft Internal Height	2120457	LHG-5BG-F8	2120497	LHG-5BG-F9
			2120459	LHG-6BG-F8	2120499	LHG-6BG-F9
			2120533	LHG-3CG-F8	2120573	LHG-3CG-F9
			2120535	LHG-4CG-F8	2120575	LHG-4CG-F9
			2120539	LHG-6CG-F8	2120579	LHG-6CG-F9

ESCO LIFESCIENCES GROUP

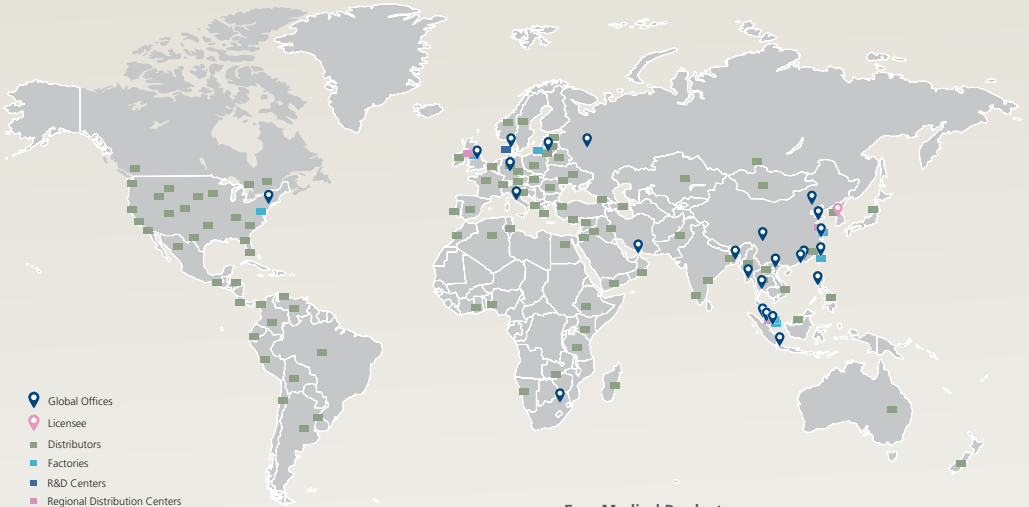

- Global Offices
- Licensee
- Distributors
- Factories
- R&D Centers
- Regional Distribution Centers



Esco Medical Products:

- MIRI® TL6 Time-Lapse Incubator
- MIRI® TL12 Time-Lapse Incubator
- MIRI® Multiroom Incubator
- MIRI® II-12 Multiroom Incubator
- Mini MIRI® Dry Incubator
- Mini MIRI® Humidity Incubator
- Esco Multi-Zone ART Workstation
- CelCulture® CO₂ Incubator
- MIRI® GA (Gas and Temperature Validation Unit)
- Anti-Vibration Table (AVT)
- Versati™ Tabletop Refrigerated Centrifuge
- CultureCoin®

Infertility is a problem that has a significant social, psychological, and economic impact on afflicted individuals and couples. It is a global concern that knows no race or creed. It has been estimated that 1 in 6 couples struggle with infertility at least once in their lifetime.

Esco Medical is one of the divisions of the Esco Lifesciences Group. We provide innovative technological solutions for fertility clinics and laboratories. We aim to become the leading manufacturer of high-quality equipment such as long-term embryo incubators, ART workstations, anti-vibration tables, and time-lapse incubators.

Our products are designed with the Silent Embryo Hypothesis as a guiding principle. The Silent Embryo Hypothesis states that the less disturbed an embryo can remain, the better its developmental potential will be. Most of our products are designed in Denmark and made in the EU. Our primary focus is to increase pregnancy success rates and patient satisfaction.



21 Changi South Street 1 • Singapore 486 777
 Tel +65 6542 0833 • medical@escolifesciences.com
www.esco-medical.com

Esco Global Offices: Bangladesh | China | Denmark | Germany | Hong Kong | Indonesia | Lithuania | Malaysia | Myanmar | Philippines | Russia | Singapore | South Africa | South Korea | Taiwan | Thailand | UAE | UK | USA | Vietnam



Designed in Denmark



Made in the E.U.

